

Simulation-based support for integrated design of new low-energy office buildings

Steffen Petersen

PhD Thesis

Department of Civil Engineering
2011

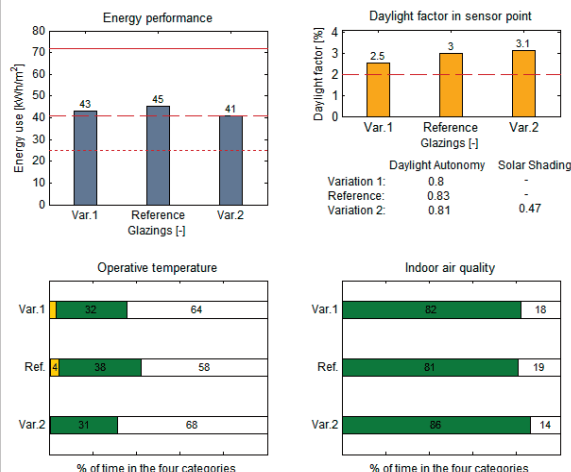

DTU Civil Engineering Report R-247 (UK)
June 2011

Simulation-based support for integrated design of new low-energy office buildings

DTU Civil Engineering Report R-247 (UK)
June 2011

**Simulation-based support for integrated design
of new low-energy office buildings**

The work described in this thesis was made possible by financial support from DTU Civil Engineering and the ALECTIA Foundation (the former Birch & Krogboe Foundation)

Printed by DTU-Tryk
Department of Civil Engineering
Technical University of Denmark
Byg R-247
ISSN: 1601-2917
ISBN: 9788 7787 7328 9

Keywords: Building simulation; Building design; Energy performance; Indoor environment

Copyright © 2011 by Steffen Petersen

All rights reserved. No part of the material protected by this copyright notice may be reproduced or utilized in any form or by any means, electronic or mechanical, including photocopying, recording or by any information storage and retrieval system, without written permission from the author.

Acknowledgements

Foremost, I would like to thank my supervisor Professor Svend Svendsen and my co-supervisor Lars D. Christoffersen for giving me the opportunity to become a PhD and for their guidance throughout this PhD study. The gratitude is also extended to the ALECTIA Foundation (the formerly Birch & Krogboe Foundation), ALECTIA A/S and DTU Civil Engineering for their financial support.

I would also like to thank all my colleagues at DTU Civil Engineering, Section of Building Physics and Services and at ALECTIA, as well as all the students participating in course '11115 – Building energy and technical services - Integrated design' from 2006 to 2009. A special thank to my friend and colleague Christian Anker Hviid for invaluable discussions and for bearing over with my constant interruptions. The competent sparring of Associate Professor Toke Rammer Nielsen, DTU, was also appreciated. Also thanks to Steven Selkowitz and his associates for all their help and inspiration in my time as a guest researcher at Lawrence Berkeley National Laboratories.

Finally, I would like to express a heartfelt gratitude and love to my family for their support and genuine interest in my work.

Foreword

"We can't solve problems by using the same kind of thinking we used when we created them."

Albert Einstein

Various approaches to the design of buildings throughout human history have led to numerous different solutions for fulfilling our need for a functional, comfortable and aesthetic shelter against the outdoor environment. However, a majority of these building designs has also front led new problems: the energy use of buildings is in general unnecessary high. Energy use in buildings contributes significantly to the rapid exhaustion of world fossil fuel reserves which again lead to rising energy prices and maybe even a negative impact on global climate. Furthermore, there are too often problems with the quality of the indoor environment which affect human health, comfort and productivity. This is not a sustainable development. Instead we need to start designing buildings with a good indoor environment and an energy need which can be covered by sustainable renewable energy sources. In order to do so, changing the way of thinking when designing buildings – or at least supplementing or adjusting it - seems necessary. The research reported in this thesis investigates a suggestion for a methodology which can be regarded as a change, supplement or adjustment of the way of thinking in the building design process. I hope the reader finds it inspiring and useful.

This thesis is submitted in partial fulfilment of the requirements for the Danish PhD degree.

Copenhagen, 31st of March 2011



Steffen Petersen

List of papers

Published journal papers

Paper I

Petersen S. and Svendsen S. Method and simulation program for informed decisions in the early stages of building design. *Energy and Buildings* 42 (7) (2010) 1113-1119

Paper II

Petersen S. and Svendsen S. Method for simulating predictive control of building systems operation in the early stages of building design. *Applied Energy* 88 (2011) 4597-4606

Paper III

Petersen S. and Svendsen S. Method for component-based economical optimisation for use in design of new low-energy buildings. *Renewable Energy* 38(1) (2012) 173-180

Technical report

Report I

Petersen S. The basis for annual, hourly lighting simulations based on bi-directional transmittance distribution functions in iDbuild.

Abstract

This thesis reports on four years of research with the aim to contribute to the implementation of low-energy office buildings with high quality of indoor environment and good total economy. Focus has been on the design decisions made in the early stages of the building design process. The objective is to contribute to a development where simulations of building energy performance and indoor environment is used for generating an input to the overall building design process prior to any actual form giving of the building. This input should be considered as one of several similar inputs from other building design disciplines (structural, fire, architecture etc.) to the integrated building design process. The research therefore revolves around the hypothesis that *parametric analyses on the energy performance, indoor environment and total economy of rooms with respect to geometry and characteristics of building elements and services can be used to generate a useful input to the early stage of an integrated building design process.*

To pursue a corroboration of this hypothesis, a method for making informed decisions when establishing the input to the overall building design process is proposed. The method relies on the use of building simulation to illustrate how design parameters will affect the energy performance and the quality of the indoor environment prior to any actual design decision. The method is made operational in a simple building simulation tool capable of performing integrated performance predictions of energy consumption, thermal indoor environment, indoor air quality, and daylight levels. The tool has been tested extensively throughout the four year period of this project. The feedback from these tests has been used to develop the operability and usability of the tool. The end result is a tool which, with minor reservations, has proved to be operational and useful in the design of low-energy office buildings with good indoor environment.

The conducted research is reported in the main body of this thesis and in three papers for scientific journals. An abstract of these is given in the following.

Article I The early stages of building design include a number of decisions which have a strong influence on the performance of the building throughout the rest of the process. It is therefore important that designers are aware of the consequences of these design decisions. This paper presents a method for making informed decisions in the early stages of building design to fulfil performance requirements with regard to energy consumption and indoor environment. The method is operationalised in a program that utilises a simple simulation program to make performance predictions of user-defined parameter variations. The program then presents the output in a way that enables designers to make informed decisions. The method and the program reduce the need for design iterations, reducing time consumption and construction

costs, to obtain the intended energy performance and indoor environment. *Paper published in Energy and Buildings 42 (7) (2010), 1113-1119. doi:10.1016/j.enbuild.2010.02.002*

Article II A method for simulating predictive control of building systems operation in the design stage is presented. The predictive control method uses building simulation based on weather forecasts to predict whether there is a future heating or cooling requirement. This information enables the thermal control systems of the building to respond proactively to keep the operational temperature within the thermal comfort range with the minimum use of energy. The method is assuming perfect weather prediction and building modelling because of the design situation. The method is implemented in an existing building simulation tool. A test case featuring an office located in Copenhagen, Denmark, shows that the suggested method reduces the energy required for heating and ventilation compared to more conventional control systems, while improving thermal comfort for building occupants. The method furthermore automates the configuration of buildings systems operation. This eliminates time consuming manual configuration of building systems operation when using building simulation for parametric analyses in the design phase. *Applied Energy 88 (2011) 4597-4606. doi:10.1016/j.apenergy.2011.05.053*

Article III Increasing requirements for energy performance in new buildings mean the cost of incorporating energy-saving in buildings is also increasing. Building designers thus need to be aware of the long-term cost-effectiveness of potential energy-conserving measures. This paper presents a simplified and transparent economic optimisation method to find an initial design proposal near the economical optimum. The aim is to provide an expedient starting point for the building design process and more detailed economic optimisation. The method uses the energy frame concept to express the constraints of the optimisation problem, which is then solved by minimising the costs of conserving energy in all the individual energy-saving measures. A case example illustrates how the method enables designers to establish a qualified estimate of an economically optimal solution. Such an estimate gives a good starting point for the iterative design process and a more detailed economic optimisation. Furthermore, the method explicitly illustrates the economic efficiency of the individual building elements and services enabling the identification of potentials for further product development. *Paper published in Renewable Energy 38(1) (2012) 173-180. doi:10.1016/j.renene.2011.07.019*

Report 1 A reoccurring issue in relation to building simulation is the desire to be able to evaluate the performance of complex fenestration systems (CFS). This report describes a method for predicting the daylight performance of CFS such as daylight redirecting devices, novel solar blinds and advanced glazing materials.

Resumé

(Abstract in Danish)

Denne afhandling er en afrapportering af fire års forskningsarbejde med det formål at bidrage til implementeringen af lavenergi kontorbygninger med høj kvalitet af indeklima og god totaløkonomi. Fokus har været på designbeslutninger i designprocessens tidlige faser. Det konkrete mål er at bidrage til en udvikling, hvor simuleringer af bygningens energipreformance og indeklima bruges til at generere et input til den overordnede designproces – før nogen egentlig bygningsform er etableret. Dette input skal betragtes som et af evt. flere lignende input fra andre designdiscipliner (bærende konstruktioner, brand, arkitektur osv.) til den integrerede designproces. Projektets hypotese er derfor, at *parametrisk analyse af rums energipreformance, indeklima og totaløkonomi med hensyn til geometri og energitekniske egenskaber for bygningsdele og installationer kan bruges til at generere et nyttigt input til den tidlige fase af en integreret bygningsdesign proces.*

For at undersøge denne hypotese, er der først formuleret et forslag til en metode til at træffe informerede designbeslutninger i forbindelse med generering af førnævnte input. Metoden bygger på anvendelsen af bygningssimulering til at illustrere hvordan en ændring af en designparameter vil påvirke energipreformance og kvaliteten af indeklimaet forud for en egentlig designbeslutning. Metoden er gjort operationel i et simpelt bygningssimuleringsværktøj, der kan udføre en integreret beregning af energiforbrug, termisk indeklima, rummets luftkvalitet, og dagslys. Værktøjet er blevet testet af flere omgange i den fireårige periode for dette projekt. Tilbagemeldingerne fra disse tests er blevet brugt til at udvikle værktøjets funktionalitet og brugervenlighed. Slutresultatet er et værktøj der, med mindre forbehold, har vist sig at være operationelt og nyttigt i forbindelse med udformningen af lavenergi kontorhuse med et godt indeklima.

Forskningen er afrapporteret i hoveddelen af denne afhandling, og i tre artikler til videnskabelige tidsskrifter. Et uddrag af disse er anført i det følgende.

Artikel I Designbeslutninger foretaget i de tidlige faser af bygningsdesign har stor betydning for det endelige bygningsdesign. Det er derfor vigtigt, at designere er klar over konsekvenserne af disse beslutninger. Denne artikel præsenterer en metode til at træffe informerede beslutninger i de tidlige stadier af bygningsdesign, således at krav til energiforbrug og indeklima kan overholdes. Metoden er operationaliseret i et simuleringsprogram, der kan bruges til at udføre bruger-definerede parametervariationer. Programmet præsenterer derefter resultatet på en måde, der gør det muligt for designere at træffe informerede beslutninger. Metoden og

programmet sikrer, at det tilsigtede energiforbrug og indeklima opnås samtidig med at behovet for designiterationer, tidsforbrug og byggeomkostninger reduceres. *Artiklen er publiceret i tidsskriftet Energy and Buildings 42 (7) (2010), 1113-1119. doi:10.1016/j.enbuild.2010.02.002*

Artikel II En metode til at simulere effekten af en vejrudsigts-baseret styring af bygningens klimatiseringssystemer præsenteres. Styringen bruger vejrudsigter som input til bygningssimuleringer for at forudsige, om der er et fremtidigt opvarmnings- eller kølebehov. Denne oplysning gør det muligt for bygningens klimatiseringssystemer at reagere proaktivt i forhold til at holde en komfortabel indetemperatur med et minimum forbrug af energi. Metoden er implementeret i et eksisterende simuleringsprogram. Et eksempel viser, at denne form for styring kan mindske den energi, der kræves til opvarmning og ventilation i forhold til mere traditionelle kontrolsystemer, samtidig med at der opretholdes et tilfredsstillende termisk indeklima. Desuden eliminerer metoden den tidskrævende manuelle konfiguration af byggesystemer i simuleringsprogrammet, hvilket er en fordel når programmet benyttes til parametriske analyse i designfasen. *Artiklen er publiceret i tidsskriftet Applied Energy 88 (2011) 4597-4606. doi:10.1016/j.apenergy.2011.05.053*

Artikel III Stigende krav til nye bygningers energiforbrug øger udgifterne til energibesparende tiltag. Bygningsdesignere bør derfor være bekendt med totaløkonomien for potentielle energibesparende tiltag forud for en egentlig designbeslutning. Denne artikel præsenterer en forenklet og gennemsigtig økonomisk optimeringsmetode til at finde et hensigtsmæssigt udgangspunkt for designprocessen og detaljeret økonomisk optimering. Metoden benytter det velkendte energirammebegreb som grænseværdi for optimeringsproblemet, som derefter løses ved at minimere omkostningerne ved at spare på energien. Et eksempel illustrerer, hvordan metoden kan hjælpe designere med at etablere et kvalificeret bud på en økonomisk optimal løsning. Et sådant bud er et godt udgangspunkt for den iterative designproces en mere detaljeret økonomisk optimering. Endvidere kan metoden bruges til at illustrere den økonomiske effektivitet af de enkelte bygningsdele og installationer, hvilket gør det muligt, at identificere potentialer for produktudvikling. *Artiklen er publiceret i tidsskriftet Renewable Energy 38(1) (2012) 173-180. doi:10.1016/j.renene.2011.07.019*

Rapport 1 Der er et stigende behov for at kunne evaluere dagslysindfaldet gennem komplekse facadesystemer (KF). Denne rapport beskriver en metode til simulering af dagslys gennem KF, såsom redirigerende lameller, innovative solafskærmninger og avancerede rudematerialer.

Table of Content

1	Introduction	1
1.1	Aim and objective	2
1.2	Research methodology.....	3
1.2.1	Overall project framework.....	4
1.2.2	Sub hypothesis I: Test environment and execution of tests	4
1.2.3	Sub hypothesis II: Test environment and execution of tests	7
1.2.4	Assessment of main hypothesis	8
2	Building design process and Building simulation	9
2.1	The building design process.....	9
2.1.1	Design as a scientific process	10
2.1.2	Design problems are 'wicked'	10
2.1.3	Designerly ways of knowing	11
2.1.4	Design as an interdisciplinary, collaborative process.....	11
2.2	Building simulation	11
2.3	Integrating building simulation in the early stages of building design	13
2.3.1	Performance verification versus design support	13
2.3.2	Barriers for integration of simulation-based design support	14
2.3.3	Towards design process integration.....	16
3	A method and tool for generating simulation-based design support.....	18
3.1	Background	19
3.2	The method.....	20
3.3	The tool	22
3.3.1	User interface.....	22
3.3.2	Exploration, analysis and presentation of results.....	24
3.3.3	Facilitation of informed design decisions	30
3.4	The role of the tool in the building design process	30
4	Operability of the tool.....	32
4.1	Iterative test of tool in master course	32
4.1.1	Description of the artificial building design project.....	32

4.1.2	Gathering data from the student projects.....	33
4.1.3	Gathering data through observations.....	36
4.1.4	Iteration 1	37
4.1.5	Iteration 2	43
4.1.6	Iteration 3	50
4.1.7	Iteration 4	57
4.1.8	Current developmental stage of the tool	62
4.2	Conclusion.....	63
5	The usability of simulation-based design support	65
5.1	Real building design projects	65
5.1.1	Office building, COM III	65
5.1.2	Multi-function building, Navitas.....	71
5.1.3	Office building, Aarhus municipality.....	76
5.2	Master projects	83
5.2.1	Master project 1	83
5.2.2	Master project 2	85
5.3	Conclusion.....	87
6	Advances in the development of the tool	89
6.1	Method for optimal control of building systems operation	89
6.1.1	The method	89
6.1.2	Reduction of time for setting up controls for building systems operation	90
6.1.3	Performance of the method	90
6.1.4	Future work	92
6.2	Method for economical optimisation in the design phase	93
6.2.1	The method	94
6.2.2	Case example.....	95
6.2.3	The method in relation to the tool for simulation-based design support.....	96
6.3	Modelling complex fenestration systems.....	97
6.3.1	The method	97
6.3.2	Case example.....	99
7	Conclusion	100
7.1	Research contribution to academia and industry.....	101
7.2	Future work.....	102
7.2.1	Further development of the tool.....	102
7.2.2	Weather forecast-based control of building systems operation	103
7.2.3	Economical optimisation method for the early design stages.....	103

7.2.4	Annual, hourly lighting simulations based on BTDF.....	103
8	References.....	104
Appendix A: Published or submitted papers		
	Paper I: Method and simulation program informed decisions in the early stages of building design	110
	Paper II: Method for simulating predictive control of building systems operation in the early stages of building design.....	118
	Paper III: Method for component-based economical optimisation for use in design of new low-energy buildings	129
	Report I: The basis for annual, hourly lighting simulations based on bi-directional transmittance distribution functions in iDbuild	138
Appendix B: Course description of master course 11115 Building energy and technical services - Integrated design.....		
		151
Appendix C: Raw data from master course		
		153

How to get iDbuild

iDbuild is available in two versions: one to run in Matlab and one to run as a Windows program without Matlab. The former includes all the source code while the latter requires the installation of Matlab runtime libraries. Both program versions and an extensive user guide are available from the web address <http://www.idbuild.dk> or by contacting the author of this thesis.

1 Introduction

The increasing strains on fossil energy resources and the need to look after the environment are issues of major concern. These are also the main reasons for the European Union's (EU) commitment to the targets of the Kyoto Protocol [1]: to maintain the global temperature rise below 2 °C, and to reduce overall greenhouse gas emissions by at least 20 % below 1990 levels by 2020. Furthermore, EU has also offered to reduce emissions by 30% in the event of an international agreement being reached [2]. In the EU, buildings are responsible for about 40% of the total energy consumption. Buildings are thus a main contributor to greenhouse gas emissions (GHG): about 36% of the EU's total CO₂ emissions and about half of the CO₂ emissions which are not covered by the EU Emission Trading System [3]. There is therefore a significant potential in reducing the energy consumption in buildings to accommodate the Kyoto protocol and more far-reaching targets. As a consequence, the Energy Performance of Buildings Directive (EPBD) [4] was introduced in 2002 as a regulatory initiative to improve the energy performance of buildings. The EPBD is a paradigm shift in regulations from individual component and system requirements to a framework for the total energy performance of the building. The minimum total energy performance requirement is set by the individual EU member states at a cost-optimal level using a certain comparative methodology framework. This national requirement has to be revised every five years, at minimum, in order to reflect technical progress in the building sector. The deadline for transposing the EPBD into national law in the member states was 4 January 2006.

Besides the demand for energy efficient buildings there are certain occupant expectations with regard to the quality of the indoor environment. Actually, the need for a healthy, productive and comfortable indoor environment is the very reason for any energy use in the first place. The EPBD acknowledges this by stating that the extent of energy savings shall take account of general indoor climate conditions to avoid possible negative effects. So, the fact is that the quality of the indoor environment and energy use (emission of GHG) are two opposite but inseparable aspects in the aspiration for a sustainable development. An energy declaration without a declaration related to the indoor environment therefore makes no sense. Such a declaration can be found in the standard EN 15251 [5]. The standard specifies criteria for the indoor environment for design, energy calculations, and performance evaluation of the building. The criteria are boundary conditions for the extent of energy savings and render possible the integral evaluation of energy use and the quality indoor environment.

The long term solution to eliminate the problems related to the emission of GHG is a combination of energy efficiency and use of renewable energy. This is also reflected in the recent recast of EPBD from 19 May 2010 which states that all new buildings constructed after 2020 should consume "near zero energy" [6]. The recast defines near-zero-energy buildings as constructions that have "a very high energy performance" with any energy they use coming "to a very large extent" from renewable sources generated "either on-site or nearby". This leads to an

increasing pressure on the building industry to produce low energy buildings while fulfilling user expectations with regard to the quality of the indoor environment. Creating an overview of possible design options and their performance prior to any actual design decisions is thus a task of critical importance. This would help building designers to integrate the task of fulfilling strict energy and indoor environment performance requirements in all design decisions related to form, constructions and systems from the early design stages. That is why the main theme of this thesis is how to enable building designers to create an overview over possible conflicts between the requirements of EPBD, comfort requirements and performance of people in the building in the early building design stages. A more detailed explanation of the aim and objective as well as the research methodology is given in the following sections of the introduction.

1.1 Aim and objective

This thesis reports on four years of research with the aim to contribute to the implementation of low-energy office buildings with high quality of indoor environment and good total economy. Focus has been on the design decisions made in the early stages of the building design process.

The objective is to contribute to a development where simulations of building energy performance and indoor environment are used for generating an input to the overall building design process prior to any actual form giving of the building. This input should be considered as one of several similar inputs from other building design disciplines (structural, fire, architecture etc.) to the integrated building design process. The objective of this research project, however, has to be defined in more specific and operational terms so it can be pursued in a scientific manner. The specific formulation depends on which description of scientific method one wishes to follow. A widely accepted and commonly used scientific method is the hypothetico-deductive method. In this method, scientific inquiry starts with the formulation of a hypothesis that could conceivably be falsified by a test on observable data. The fact that the hypothesis should be formulated so it may be shown false is crucial according to Popper [7]: one cannot regard a proposition (or theory) as scientific if it does not admit the possibility of being shown false. The criterion of falsifiability may have been rejected or supplemented by other philosophers of science but it is still a prevailing paradigm in scientific investigations. The test of a falsifiable hypothesis based on the aforementioned objective would therefore be a scientifically solid approach for pursuing the aim of the research. To pursue the above described aim and objective, the following hypothesis is thus drawn up:

Parametric analyses on the energy performance, indoor environment and total economy of rooms with respect to geometry and characteristics of building elements and services can be used to generate a useful input to the early stage of an integrated building design process.

According to the hypothetico-deductive method, the hypothesis above is currently just a provisional idea whose merit requires evaluation through tests. There are two possible outcomes of such tests: 1) they may run contrary to predictions of the hypothesis thus falsifying the

hypothesis or 2) *not* run contrary to the hypothesis thus corroborating the hypothesis. If a hypothesis is corroborated by an appropriate number of tests, the next step could be to compare its explanatory value to competing hypotheses by testing how stringently they are corroborated by their predictions.

This research project is limited to the task of testing the hypothesis above. There will be no attempts to compare a potential corroborated hypothesis with competing hypotheses within the research area. The next step is therefore to describe the adopted research methodology to test the hypothesis, see section 1.2.

1.2 Research methodology

The hypothesis in section 1.1 is in its formulation directly testable. The test, however, seems like an overwhelming task since the hypothesis gives rise to a number of questions¹:

Question 1: *Is it possible to establish an operational tool for parametric analyses on the energy performance, indoor environment and total economy which can be used for generating input to the building design process?*

In question 1, the term 'operational' is crucial. According to Nielsen [8], usability (or operability) of e.g. a piece of software is a part of 'usefulness' and is composed of five issues, 'learnability', 'efficiency', 'memorability', 'errors' and 'satisfaction'. The definitions of the first two issues are especially interesting in relation to this research project: 1) the learnability of the tool, i.e. how easy it is for users to accomplish a task the first time they encounter the tool, and 2) the efficiency of the tool, i.e. whether the users find the tool 'easy to use' once they have learned to use it.

Question 2: *Is the output from the parametric analyses useful in the overall building design process?*

The above questions indicate a possibility to divide the test of the hypothesis in two, namely whether it is possible to use parametric analyses to generate a certain input to the building design process (question 1) and whether this input is useful in the overall design process (question 2). In relation to these two questions, a third question seems relevant if question 1 and/or 2 is answered with a 'no':

Question 3: *What are the main barriers for an efficient application of parametric analysis?*

¹ 'Questions' are formulated instead of the formulation of 'predictions' which would be more scientifically correct. 'Questions' and 'predictions' are, however, related since they are both products of reasoning over the hypothesis. 'Questions' are used here because this form is found more communicative.

Question 1 gives rise to the notion that the task of establishing 'an operational tool for parametric analyses of the energy performance, indoor environment and total economy' could be divided in two. Building energy performance and indoor environment are an inseparable matter but total economy can be regarded as a separate matter. It can therefore be argued that these two matters could be investigated separately to further facilitate the research work needed to test the main hypothesis. It is therefore decided that *total economy* initially is left out. Total economy could be included when the tool is considered to be fairly operational for parametric analyses of the energy performance and indoor environment alone. The following predictions, or sub hypotheses, can now be formulated:

Sub hypothesis I: *It is possible to establish an operational tool for parametric analyses on the energy performance and indoor environment which can be used for generating input to the building design process.*

Sub hypothesis II: *The output from the parametric analyses is useful in the overall building design process.*

Sub hypothesis I and II are henceforth called 'SH I' and 'SH II', respectively. These two sub hypotheses are the initial test subjects in this research project. The outcomes of these tests are then used to make a qualified assessment of the main hypothesis so that a set of conclusions in relation to whether the hypothesis is falsified or corroborated can be drawn up.

So, basically the overall research methodology to test the hypothesis is that the test of two sub hypotheses provides the basis for a test of the main hypothesis. Performing a solid test of the sub hypotheses demands appropriate test environments and careful planning of their execution. These elements are described in the following.

1.2.1 Overall project framework

Appropriate test environments accommodating the demands described above were found within the overall framework conditions of the research project. The research was planned to be undertaken over a period of four years. A typical week or month within this period was divided in $\frac{3}{4}$ of research activities at the Technical University of Denmark (DTU) and $\frac{1}{4}$ of professional building consultancy in the company ALECTIA A/S. The field of work in the consultancy was energy performance and indoor environment in buildings, and the assignments were often the role as consultant in competitions and conceptual design tasks. This mix of research and professional consultancy was immediately a unique constellation in terms of establishing appropriate test environments for execution of the tests of SH I and SH II.

1.2.2 Sub hypothesis I: Test environment and execution of tests

Initially, a proposal for a method and tool for generating simulation-based design support is established (see chapter 3 and Paper I in appendix A). The tool is the 'tool for parametric analysis' mentioned in SH I and the method is an attempt to make the tool 'operational', i.e. an attempt to

facilitate the generation of '*a useful input to the design process*'. Whether the use of the method and tool indeed corroborates *SH I* relies on an analysis of the outcome from design projects where the proposed method and tool has been applied.

The test environment for *SH I* would benefit from involving a large number of potential users of the, still alleged, *operational tool for parametric analyses for generating input to the building design process*. One could argue that the more potential user testing the tool, the more solid the evidence for any conclusions in relation to *SH I* (and consequently the main hypothesis) is. Furthermore, it is the intention to stimulate an iterative, user-driven development of the tool. The reason is that the needs for enhancements of the tool are most likely experienced by users working with the tool rather than by the tool designers. This point of view is promoted e.g. by Fischer in ref. [9]. Fischer has also formulated the 'seeding, evolutionary growth, and reseeding' model (SER) [10] which postulates that systems that evolve over a sustained time span must continually alternate between activities of unplanned evolution and periods of deliberate (re)structuring and enhancement. The SER model can be summarised in the following high-level guidelines:

- *Software systems must evolve; they cannot be completely designed prior to use.* Software users and designers will not be able to fully determine a system's desired functionality until that system is put to use.
- *Software systems must evolve at the hands of the users.* Users (not developers) experience a system's deficiencies. They therefore have to play an important role in driving its evolution.
- *Software systems must be designed for evolution.* Experience has shown that the time (costs) saved in the initial development of a system by ignoring evolution will be spent several times over during the use of a system.

It is the intention to follow the guidelines of the SER model when testing *SH I*. This makes certain demands on the test environment.

The test environment chosen for *SH I* was a course at DTU called 'Building energy and technical services - Integrated design' [11] running each fall semester (Sept.-Dec.). Here, a total of 67 student groups or approx. 140 students (apportioned over the four year period of the project) have used a tool for parametric analyses developed specifically for this research project (see Paper I in appendix A) to generate input to an artificial building design project. This test environment was ideal for applying the SER model described above. The user feedback from the course and direct observations of the students working with the tool were used to test *SH I* and to identify possible improvements to the tool with the aim to further corroborate *SH I*. The opportunity to test *SH I* once a year for four years enabled an iterative research process where issues which hindered corroboration of *SH I* were identified (question 3) and accommodated before the tool was tested once again. A flow diagram of the execution of the test of *SH I* is shown in Figure 1 (a).

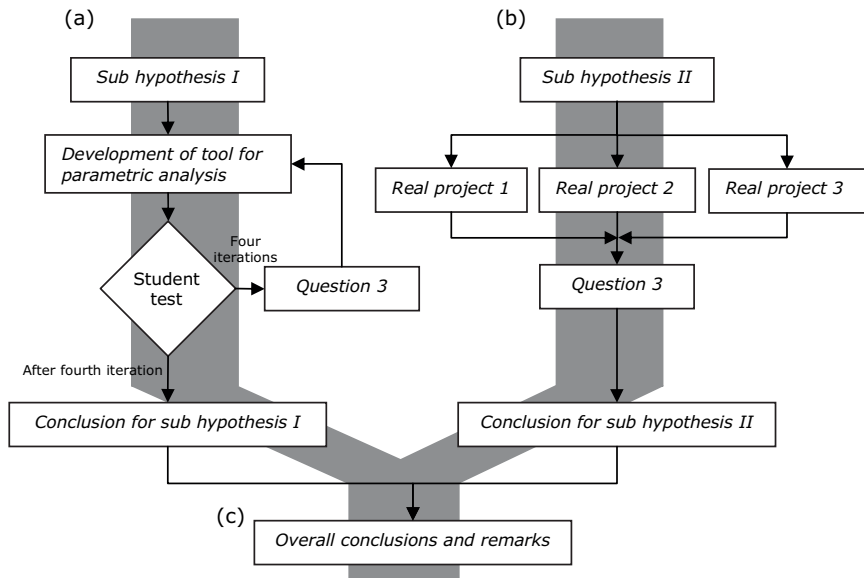

Figure 1. A flow diagram of the research methodology for the project: (a) execution of the test of SH I, (b) execution of the test of SH II, and (c) overall conclusions and remarks based on the outcome from (a) and (b).

The disadvantage of a test environment within a university course was that it was not the same users performing the test each year. As a consequence, any improvements to accommodate barriers for efficient application of the tool were not tested by the same set of users who provided the basis for the suggested improvements. This disadvantage, however, only seems to apply for the test of the implementation of concrete suggestions² for improvements provided directly by a specific set of students. Testing the implementation of possible improvements to accommodate more general issues identified by the students, e.g. the notion of excessive use of time, on a different set of students may be easier to justify. In such a case the students rarely provided any reasons or concrete suggestions for improvement. Instead, improvements have to be suggested based on the tool developer's (i.e. the author of this thesis) overt participant observations of the students working with the tool. Three of such suggested improvements are described in paper II, paper III and Report I in appendix A. Paper II is aimed at facilitating the set-up of the control of building systems operation, paper III is aimed at reducing the amount of design iterations by establishing an energy-economic efficient starting point for the parametric analysis, and Report I sketches a method to predict the performance of complex fenestration systems in the early design stage (see section 6.1, 6.2 and 6.3, respectively).

An alternative, or possibly parallel, test environment would have been to introduce the tool to engineers at ALECTIA A/S and ask them to use it in their daily work while observing them. This more practical environment may have provided a better qualitative basis for the test of SH I but

² An example of a relatively frequent user suggestion is suggestions on how to improve the user interface.

would never give access to the same quantity of test persons as in the student course. Observing only one or a few projects was also regarded to be an inefficient use of the time and resources of the project since any issues that might be experienced in one project may not be experienced in another thus making it difficult to justify any improvements to the tool. Furthermore, it was expected to be difficult to arrange the iterative process of the SER model within this test environment. Finally, the limited time and resources of the project necessitated a prioritisation. Therefore, the qualitative test environment within ALECTIA A/S was deliberately deselected in favour of the quantitative test environment provided by the student course.

1.2.3 Sub hypothesis II: Test environment and execution of tests

The characteristics of test environment needed for the test of *SH II* is more obvious than for *SH I*. The test environment has to be a professional setting where interdisciplinary design teams are working on a real building design project in their everyday context and within real constraints. This is the only setting where it would be possible to perform a realistic test of whether *the output from the parametric analyses is useful in the overall building design process*.

The fact that the research project was partially anchored in a professional consultancy enabled the author to be a part of the design group of three real building design projects. These three projects were providing the ideal conditions for tests of *SH II*. In all projects, output from the tool was presented to the design group at an early stage of the process as an input to the integrated building design process. The data basis for a test of *SH II* was then generated by observing how the design group was using this input and through interviews with the participants of the design groups.

A flow diagram of the execution of the test of *SH II* is shown in Figure 1 (b). Here it is illustrated that the projects were given equal status in relation to identifying any barriers for an efficient application of parametric analysis. The reason was that the framework conditions for real building design projects often are very different from project to project, e.g. in relation to the type of the project (e.g. dwelling, office, school or a mixed function), number and type of people involved and the time frame available for conceptual design. Consequently, any issues that might be experienced using the output from the tool in one project may not be experienced in another. Therefore, it might be difficult to justify any improvements to the tool based on the experiences from a single design project. One could even argue that the data gathered in the three projects are not sufficient to establish a pattern that may justify any improvements. The three projects, however, may constitute the start of a pattern in terms of identifying potential improvements and they may give some indications in relation to whether *SH II* is corroborated or not.

Furthermore, the tool was used in two master projects where the aim was to design a low-energy office building with high indoor environment quality. In master project 1, the project was not a real building design project and the students were not a part of an interdisciplinary design team. But maybe because of this, combined with their lack of experience in building design, they could provide new dimensions in terms of *SH II* (i.e. the usability of the design support) as they were not bound to follow any traditional notions and conventions regarding the building design process.

Instead, they were free to apply the generated design support to the building design process in any way they wanted. In master project 2, the students were fortunate to have the opportunity to be involved in a real building design project. The students therefore had, in contrast to master project 1, the opportunity to gather data and experience regarding how the alleged useful design input generated with the tool was perceived and maybe used in a real, multidisciplinary practice setting.

1.2.4 Assessment of main hypothesis

The final part of the research is to make an assessment of the main hypothesis based on the conclusions made in relation to the test of sub hypothesis I and II. Finally, overall conclusions and remarks are provided. This is illustrated in Figure 1 (c).

2 Building design process and Building simulation

This section describes state of the art in two topics, namely 1) building design process and 2) building simulation. These topics are highly relevant to the research reported in this thesis as they are basic elements in the objective as well as the hypothesis.

Designing a building often happens through series of activities and procedures which as a whole is referred to as a building design process. It is not an objective of this thesis to make a new suggestion for a building design process but merely to inform that process in a constructive manner. Being aware of the different notions of the building design process, their background, and the current prevailing trends is therefore important to ensure that the outcome of the research becomes relevant for building designers working in practice.

A core issue in the research reported in this thesis is how to use building simulation prescriptively rather than evaluative. In its relation, it is desirable to 'stand on the shoulder of giants'³ to a widest extent possible and to be aware of the current directions in the development of building simulation.

Finally, building design process and building simulation is 'crossed'. Current attempts to integrate building simulation in the early stages of building design are described and analysed, and serves as further rationale for the direction of research reported in this thesis.

2.1 The building design process

Design of buildings has long moved away from what Lawson [12] calls the craft-based approach, where buildings are the result of generations of evolution with an end product that is a totally integrated response to a limited number of problems (e.g. the local climatic conditions). The reason is that the craft-based evolution became too slow to adapt to the relatively sudden and rapid changes in user demand, regulatory requirements and technology found e.g. in western countries. According to Alexander [13], the consequence for the building design process has been a transformation from an unselfconscious tradition-based approach to a self-conscious professionalised process.

In other words, design has become a complex task. Stricter and sometimes opposing user demands and regulatory requirements together with an increasing amount design options due to the rapid development of technology are the immediate obvious reasons. Furthermore, Alexander

³ The modern interpretation of this statement was made famous by Sir Isaac Newton and means that one should develop future intellectual pursuits by understanding the research and works created by notable thinkers of the past.

(ibid.) states that the cognitive burden in self-conscious cultures is in itself inducing a higher degree of complexity. The increased complexity is the main reason that design has become a subject of research. A review of the historical developments in design research is given in sections 2.1.1, 2.1.2 and 2.1.3, and in section 2.1.4 the development is related to one of the latest trends in building design processes. The purpose is to gain insight into the fundamental notions of the modern design process in order to establish a platform for suggesting constructive initiatives for the facilitation of the building design process.

2.1.1 Design as a scientific process

The earliest efforts to define the design process were focused on approaching design using the classic scientific methodology in an attempt to justify design as an academic, scientific discipline. These so-called first generation design methods were formulated in the 1960s by early pioneers like Archer [14] and Asimov [15]. The methods were constructed with a focus on optimisation using the term 'method' in its classic scientific meaning where a 'method' is considered to be a systematic, rational and logical way of approaching a problem – in this case design problems. A leading mantra in the quest of such methods is the notion 'Form Follows Function' formulated by Sullivan [16], which means that a form must facilitate a given set of functional needs. Design methods rooted in this mantra are therefore trying to find the causal relationship between form and function, typically through one of the two fundamental paradigms 'problem-solving' or 'puzzle-making', where problem-solving is the search for a form which facilitates a desired function and puzzle-making is the adaptation of a form until it reaches some desired functional qualities [17].

2.1.2 Design problems are 'wicked'

The so-called second generation of design methods emerged in the late 1960s/early 1970s. Researchers wanted to abandon the problem solving approach of the first generation of design methods which they criticised for being too narrow and functional contingent definition of rationality not fit for design problems. Instead, supporters of the second generation argued that design problems, especially architectural design problems, are 'wicked' problems full of intuitive leaps, fundamentally irreconcilable with the techniques of science and engineering, which dealt with 'tame' problems [18] [19]. Because design problems are perceived as wicked problems they are fundamentally indefinable which means that it is impossible to determine when a design problem is solved: it can always be improved. Thus no ultimate, optimal solution exists [18] [20] [21]. The second generation researchers argued that the design process is argumentative and based on empirical knowledge, rather than rational knowledge as in the first generation design methods, beginning with an incubation, an introspective phase, followed by iterative refinement of both form and function until some harmonious coexistence emerges [22], a so-called satisfactory solution [23].

2.1.3 Designerly ways of knowing

A notion emerging in the 1980s, based on the second generation design methods, is that there is a 'designerly' way of knowing, e.g. Schön [24] and Cross [25]. Where science and art (or humanities) are two well-established cultures of knowing, designerly ways of knowing is considered to be a 'third culture'. The notion in the third culture is that there are forms of knowledge special to the awareness and ability of a designer, independent of the different professional domains of design practice [26]. The research in this third culture is based on the reflective practice of design, and therefore considers design as a discipline rather than a science. Therefore the research in designerly ways of knowing often relies on studies of design activities with the purpose of mapping what is called 'the creative cognition in design'.

2.1.4 Design as an interdisciplinary, collaborative process

The development described in section 2.1.1, 2.1.2 and 2.1.3 is mainly concerning the design ability of the individual designer. Today, designers relying on first generation approaches (systematic and rational) are mainly found in engineering and industrial design whereas designers relying on second generation approaches (argumentative and empirical) are mainly found in architecture and planning [28]. 'Designerly' ways of knowing is an attempt to make design an independent culture but is still concerning the ability of the individual designer.

In the building design process, design ability is of course important. However, a mix of abilities is often required to solve today's design problems. For example, the aesthetic aspect of a design project might gain from an argumentative approach whereas the structural aspect might gain from a more systematic and rational approach. Common is that these design aspects, as well as many other aspects, often require expert knowledge and years of training. It is therefore hard to believe that the individual designer alone possesses all the abilities to solve today's design problems. As a consequence, current frameworks for the building design process rely on a high degree of interdisciplinary collaboration. Such frameworks are often referred to as 'integrated design process' (IDP), for example in IEA Task 23 [29] and BC green building roundtable [30]. In IDP the term 'design team' is often used instead of 'the designer'. The design team is a group of individuals with different, specialised design abilities. In IDP the design team is the designer. The idea is that a multidisciplinary collaborating design team is more likely to succeed in solving the complex building design task. In this context, the structure of the design team is of importance to ensure that the team is competent to transact decisions. The above cited references elaborate on this and on other issues relevant to the interdisciplinary, collaborative design process.

2.2 Building simulation

As stated in section 2.1, the modern building design process is complex due to strict and sometimes opposing user demands and regulatory requirements as well as an increasing amount design options due to the rapid development of technology. Establishing an overview of which combinations of design options that may prompt the desirable performance can be difficult for building designers because it often requires the management of a large amount of data on

geometry and detailed physical properties of building elements and systems. As if this were not enough, this data needs to be processed before anything can be said about performance (e.g. energy need and indoor environment quality). Computer-based building simulation tools are, however, ideal for both data management and for processing data in a way so it may provide the designer with useful information on the performance of building design proposals. The principle of computer-based building simulation can be divided in four issues: 1) physical modelling, 2) the development of a mathematical model, 3) computation, and 4) representation of results. Physical modelling is an attempt to represent the behaviour of a real building by describing it as a set of internal and external variables with distinct boundaries. The equations that describe the relations between the variables of the physical model are the mathematical model. When input to the variables of the physical model is given, the equations that make up the mathematical model can be solved (computation). Finally, the results can be displayed numerically and/or graphically.

The historical evolution of building simulation tools for predicting energy performance and indoor environment of buildings is well-described by Clarke [31] and is used in many studies, e.g. by Morbitzer [32] and Prazeres [33]. From these descriptions it is clear that the so-called 3rd generation of tools, which are based on numerical techniques and capable of integrated modelling⁴, are the backbone in today's development. Clarke [ibid.] also indicates a 4th generation of simulation tools where focus among other things is on the development of user interfaces, application of quality control and user training due to the growing uptake by practitioners.

The underlying simulation method of the 3rd generation tools may differ. In general, the methods can be categorised in four types: stand-alone, interoperable, run-time coupled and integrated. The characteristics, advantages and disadvantages, and examples of implementations of the different methods are summarised in Table 1.

Table 1. Overview of simulation methods (from Citherlet [34]).

Method	Characteristics	Advantages	Disadvantages	Examples
Stand-alone	Several unrelated applications are used separately.	- Problem specific.	- No data exchange. - New model per application. - Several interfaces.	- DOE-2 [35] - RADIANCE [36]
Interoperable	Applications can share or exchange parts of or the whole building model, but not during the simulation process itself.	- Data and model consistency.	- No dynamic data exchange. - Maintenance of the data transaction feature. - Several interfaces.	- IES-VE [37] - SEMPER-II [38] - ECOTECT [39]

⁴ Integrated modelling is thermal, visual and acoustic aspects of performance considered together.

Run-time coupling	The connection (or linking) of applications at run-time. Information is exchanged in a co-operative way	<ul style="list-style-type: none"> - Dynamic data exchange. - Data and model consistency. - Single user interface. 	<ul style="list-style-type: none"> - Maintenance of the data transaction feature. 	<ul style="list-style-type: none"> - Thermal and lighting [40] (ESP-r [41] and RADIANCE [36]) - Heat flow and CFD [42]
Integrated	Applications merged at algorithmic level.	<ul style="list-style-type: none"> - Dynamic data exchange. - Data and model consistency. - Single user interface. - Application maintenance. 	<ul style="list-style-type: none"> - Requires knowledge of the involved domains. 	<ul style="list-style-type: none"> - Thermal and lighting [43] (BuildingCalc [44] and LightCalc [45]) - EnergyPlus [46] (DOE-2 [35] and BLAST [47])

2.3 Integrating building simulation in the early stages of building design

A study by Crawley et al. [48] describes twenty of the leading sophisticated building simulation programs based on the 3rd generation approach. Many of these tools were originally developed by researchers, for research purposes. This original purpose makes them difficult to integrate in the early stages of the building design process. The problem is according to Radfort and Gero [49] that the information provided by simulation tools often is evaluative rather than prescriptive which makes them inefficient for exploration of the solution space. This point of view was formulated in 1980. About 16 years later, in 1996, the same reason is given by Mahdavi et al. [50] who finds that attempts to develop tools to support the design process has resulted in a program functionality which reflects the traditional notion of the design process where formal and aesthetic decision-making and the fulfilment of building performance requirements are considered as discrete and sequential rather than being concurrent activities. In short, the development of tools is still focused on performance verification rather than design support. Mahdavi et al. [ibid.] therefore call for a critical review of the traditional design process as well as a re-examination of tools to enable designers to make simulation-based design decisions. The integration issue is still relevant seven year later in 2003, where Morbitzer [32] states that the development of new simulation functionalities and capabilities also has to consider how they can be integrated in the building design process. Hand [51], Augenbroe [52], de Wilde [53] and Donn [54] are among others who in their recent research stress the importance of the process dimension along with tools developments to realise the integration of building simulation tools in the design process.

2.3.1 Performance verification versus design support

The problem in using simulation tools for performance verification and not for design support is that the number of flexible design parameters decreases as the design process moves forward. The development in the cost of project changes is opposite, see Figure 2. As simulation-based

performance verification is applied late in the design process, the resolving of any problems identified by simulations are forced to rely on expensive sub-optimisations.

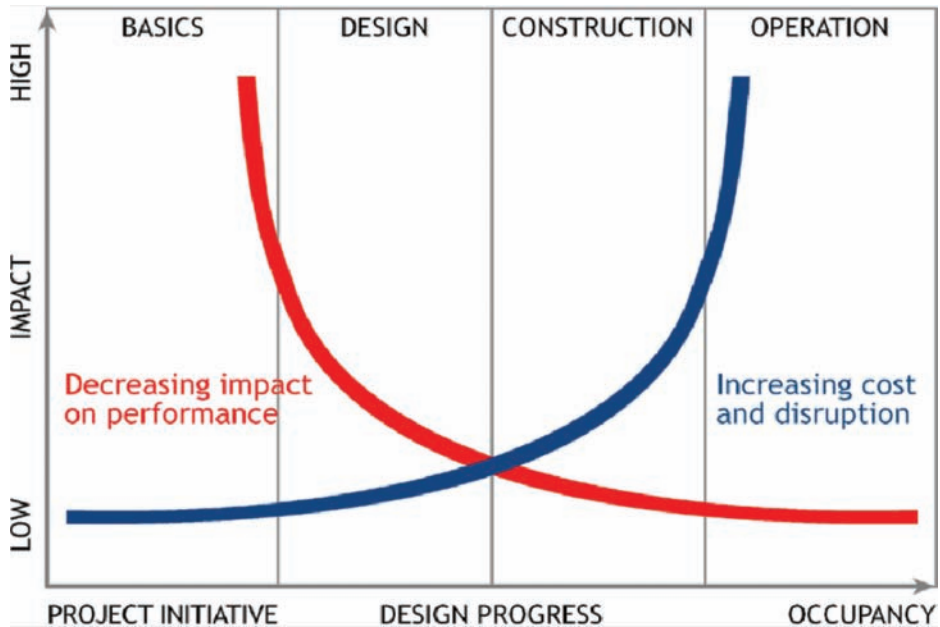

Figure 2. Relation between life of building and design decisions' impact on performance and cost (from IEA task 23 [29]).

A current movement in research is aimed at enhancing the use of building simulation tools in the early stages of building design. The notion is that the use of simulation tools at an early design stage could provide designers with insights at a time when it would have a potential impact on design decisions. As stated earlier, it is broadly acknowledged that the development of simulation tools for early stages of design need to have a design process dimension. Consequently, new and existing tools with facilitating interfaces and support for exploration of performance data are often presented together with proposals for procedures and methodologies to integrate their use in the building design process, e.g. Soebarto and Williamson [55], Morbitzer [32], Augenbroe et al. [56], Ochoa and Capeluto [57], Petersen and Svendsen (Paper I in appendix A) to cite a few. There are, however, still some issues and barriers which have to be addressed to fully integrate the use of simulation tools in the early stages of the building design process.

2.3.2 Barriers for integration of simulation-based design support

Early attempts to integrate building simulation in the building design process have revealed a number of barriers. A detailed overview of these attempts is given by de Wilde [53], who summarises the barriers as:

- *Unavailability of appropriate computational tools or models.* The limited scope and facilities of tools. Lack of tool interoperability, run-time coupling or integration.

- *Lack of trust in computational results.* Distinct among other than simulation experts and tool developers. A notion of a lack of usefulness and clarity of results in a design context.
- *A high level of expert knowledge needed for full use of simulation tools.*
- *High costs.* There is a significant use of time (and thereby money) connected with simulation efforts.
- *Information gap.* Problems related to data exchange between 'design' and 'simulation'. Inputs for simulation in a certain tool are missing or are unavailable.

All of the above barriers are bottlenecks contributing to a loss of momentum in the early stages of design. This momentum may be considered more important than simulation results. If so, there is a risk that the potential design option undergoing a simulation has been abandoned for other reasons before the simulation is finished.

Even though these barriers often are addressed in current research and development, they tend to re-emerge due to the rapid and sudden changes in user demand, regulatory requirements and technology. The barriers therefore have to be addressed continuously in the development of new methods and tools for simulation-based design support. The barriers are often accommodated by focusing on the following tool-related issues:

- *Ease of data entry.* Provide better understanding of the input data without contributing to information overload and facilitation to close the information gap.
- *Ease of output interpretation.* Adding interpretive sophistication for processing the simulation output data.
- *Development of the simulation 'engine'.* A continuous improvement of program interoperability, run-time coupling or integration is necessary to gain full and accurate overview of building performance. Development of new features also has to consider the process dimension.

The tool-related issues are considered to be general: increased facilitation of building simulation is of interest regardless of the expertise level of the building simulationists. However, there is a risk that a focus on facilitation ends up being the implementation of 'engine' simplifications. Donn [54] states that the simplification of rigorous performance prediction equation (or set of equations) trivialises the issues. The reason is that in an effort to encourage the use of a tool, there is a risk that the simplified model becomes so remote from the complexity of reality that the tool is perceived as irrelevant.

There seem to be a thin line between the desired facilitation and unwanted simplification in the effort to make tools for simulation-based design decisions in the early stages of design. To avoid crossing this line, proposals for facilitation might be found when investigating more design process-related issues. Proposals related to design process-related issues are, however, more complex and sometimes controversial. Especially because the early design stages traditionally are considered the domain of architects who are focussing on formal and aesthetic issues, which is claimed only solvable through intuitive approaches due to the 'wicked' nature of building design,

see section 2.1.2. Ward [58] presents a radical viewpoint on this by suggesting that this is an intentional attempt to mystify a process as a means to gain power in the decision-making process. This illustrates that even though research findings are presented as arguments the discussions regarding the design process tend to become opinion-based and emotional. Despite the risk of being involved in such discussions, it is the notion of the author that certain process-related issues have to be addressed if the integration of simulation-based design decisions is to succeed.

2.3.3 Towards design process integration

Let us assume that building design, especially its initial stage, is a 'wicked' problem where 'intuitive leaps' in the mind of the designer (often an architect) rule the direction of the design. If the leaps themselves are considered to be indisputable design decisions no integration of simulation-based design decisions will ever take place. A precondition to the integration is that the designer allows the simulation of the consequence of these leaps before making an actual design decision. A potential barrier in this scenario is therefore the mindset of 'the designer'⁵.

One way of addressing this barrier is to develop simulation tools that are adapted to the design process and not vice versa. This integration approach is characterised by attempts to make architects (non-simulation experts) adopt the use of simulation tools in the early stages of design by providing facilitating input interfaces to sophisticated simulation tools and make intuitive output data presentations. Simulation experts are consulted in the later, detailed design stages if necessary. An example of this is Morbitzer [32] who manage to get good feedback from architects on the use of so-called ODS-interfaces (Outline Design Stage) that facilitates the creation of detailed simulation models and Integrated Performance Views (IPV) for better interpretation of results.

Another approach is based on the notion of the building design process has to rely on a high degree of interdisciplinary collaboration, e.g. as in the integrated design process (IDP), see section 2.1.4. This means that 'the designer' is substituted with a cooperating 'design team'; a group of experts relevant to the scope of the project. A precondition for the IDP is that the mindset of the members of the 'design team' is focused on interdisciplinary collaboration. The mental barrier caused by the desire for architectural unilateralism of 'the designer' therefore has no livelihood. A project structure around a 'design team' is therefore ideal for the integration of simulation-based design decisions in the early stages of design: it is obvious to include simulation experts and their tools in the design team. This is a well-known way of attempting to integrate the use of simulation tools in the design process. McElroy [59] suggest that instead of using simulation specialists as a service which is separate or detached from the design process, see Figure 4., specialists should work from within the design team. This way a two-way flow of information occurs: simulation know-how is passed directly to practitioners, and simulation specialists face real design issues, see Figure 6.. The experiences of McElroy [ibid.] are that this form of simulation-based design, quote: "*...undoubtedly yield results, quicker, cheaper and better*

⁵ It is noted that the mental barrier of the designer may be caused by the tool-related issues listed earlier in this section.

than conventional methods... This has resulted in enhanced design quality, and (more importantly) increased business for participating companies.” (p. 309-310).

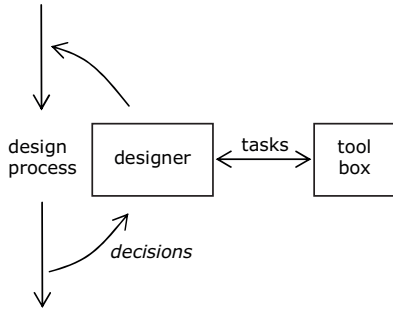

Figure 3. The tool box approach (according to Maccallum referenced by Clarke [31] page 4). Simulations are detached from the design environment.

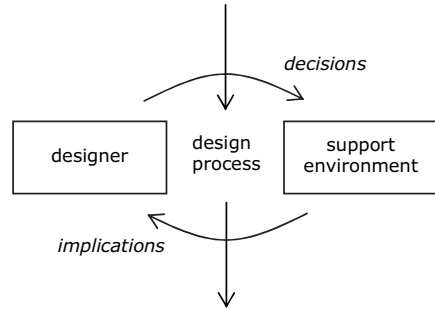

Figure 4. The integrated approach (after McElroy [59]). Simulations (support environment) are fully integrated into the design environment.

Another research outcome following the notion of interdisciplinary collaboration is produced by de Wilde [53], who in the development of the so-called DAI-prototype (Design Analysis Integration) assumes an expert consultant as user who contributes to a design team effort.

As described in section 1.1 and 1.2, the research reported in this thesis is on the development an operational tool for simulation-based input to the integrated design process. The research builds on the notion that expert consultants are taking care of integration as the ‘support environment’ in Figure 4.. The current workflow may be effective to generate simulation-based information about design implications. But process-wise this trial-and-error workflow could result in a loss of momentum because the designer in the case of undesired performance is left clueless in terms of means to remedy the design and has to rely on exhausting trial-and-error exercises. The support environment, however, has the potential to become more proactive in the building design process by also providing simulation-based design advice along with design implications⁶. This is exactly what the objective and the hypothesis of this thesis aims at: to enable the support environment to generate input to the overall building design process prior to any actual design decisions, see Figure 5.

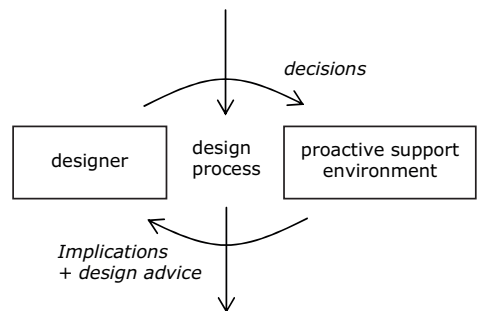

Figure 5. The proactive support environment can, besides implications of design decisions, also provide constructive design advice.

⁶ A derived benefit from this could be that non-simulation experts gains a better overall understanding of the relationships between design factors and building performance.

3 A method and tool for generating simulation-based design support

"With the emergence of these high-tech slide rules we are getting back to the dynamic process. What a relief."

Jan Søndergaard

"It is the question about the hen or the egg..."

Thomas Herzog

An often used argument for the necessity of an integrated design process, i.e. a design process relying on a high degree of interdisciplinary collaboration from day 1, is that design decisions made in the early stage tend to commit the environmental performance throughout the remaining design process [29] [60]. A similar argument is that designers uninformed of the consequences of design decisions risk specifying "environmentally friendly" measures that jeopardise the overall performance of a building depending on the overall context they are put into [61]. With this and the main hypothesis of this project in mind, the initial aim was therefore to propose a method and tool for generating simulation-based design support which helps designers to integrate the fulfilment of certain energy performance and indoor environment requirements in their earliest design decisions. It is the intention to generate this design support prior to the actual form giving of the building. The use of building simulation this early in the design process rules out the traditional, evaluative use of building simulation since there is no building design to evaluate. Instead, basic information on the spatial needs for different functions of the building and the use of building simulation for parametric analyses on the energy performance and indoor environment is used to generate proposals for room designs which can be used for design support in the overall building design process.

This chapter is based on Paper I: Method and simulation program informed decisions in the early stages of building design (see appendix A). The overall message of this paper is that the use of a certain method operationalised in a building simulation tool might be an expedient way to generate useful input to the building design process. This chapter gives a more detailed background for and further rationale for the proposed method and tool for generating simulation-based design support.

3.1 Background

The task of performing a building simulation traditionally requires a building geometry and knowledge of the physical properties of building elements and systems. This is a high level of detailed information which rarely is present in the early stages of the design process. Furthermore, the early stages of the design process is characterised by a high level of activity in relation to the more architectural aspects of building design which means that the overall building geometry is reconfigured and changed many times before a satisfying architectural solution is found. Consequently, there is a risk that the building geometry has changed many times over before the building simulationist has finished even modelling the first geometry suggestion. In this case building simulation becomes irrelevant to the other design activities the early stages of the design process, and is far away from generating proactive design support.

It is in the light of the above risks that it is suggested to concentrate a substantial amount of the building simulation efforts in the early of the design process on the performance predictions of rooms rather than the whole building. The main practical reasons are that performance simulation on room level compared to simulations on building level requires a lower level of information, and less modelling effort and simulation time. Therefore, all other things being equal, performance predictions on room level may be easier to at least keep up to date with the other activities in a dynamic design process. With some effort performance predictions on room level may even have the potential to be a platform for proactive generation of design advice in the form of a range of room designs which fulfils pre-established performance requirements. However, the cardinal argument for making performance predictions and generate design advice through room level simulations is that it makes no sense to discuss the quality of the indoor environment on building level as indoor environment is very much dependent on the function and other characteristics of the room. The quality of indoor environment must be discussed on room level. Besides providing insights on the quality of the indoor environment, building simulation can also provides the energy consumption of the room. Energy performance like indoor environment varies from room to room depending on the function and e.g. solar gain (heating and cooling need) and daylight access (need for electrical lighting). The simulation of energy performance on room level may therefore provide useful insights in relation to the overall energy need of the total building design.

The drawback in relation to providing design support as analyses on room level is that it could be argue that assessment of energy and indoor environment performance should also account for heat transfer between adjacent rooms, overall system losses, and other issues which occurs on building level. However, this might be a level of detail which is difficult to include in the early stage of building design – especially because information is scarce. It is therefore claimed that design support based on performance simulations on room level (leaving out issues which occurs on building level) is sufficient in terms of addressing issues regarding energy performance and quality of indoor environment in the early building design stage. However, after an overall building design is established (e.g. by using the proposed room designs along with a range of other inputs as design support), the energy engineer of the design team may (or should) include

any issues occurring on building level that may affect energy and indoor environment performance.

3.2 The method

The suggested method for generating proposals for room designs, which should be regarded as design support, is based on the 'performance-based design' paradigm as it is formulated by Kalay [62]. According to Kalay, building design is an iterative process of exploration, in which alternative shapes for fulfilling certain functional traits are suggested and evaluated in a given context. Making an actual design decision relies on the designer's ability to explicitly represent, and then reflect upon, the desirability of the performance of a certain constellation of form, function and context. A major advantage of the performance-based design paradigm is that it is easy to formalise as a practical workflow, see Figure 6. In this workflow it is obvious to let building simulation tools take care of performance prediction in relation to energy performance and indoor environment. With minor adjustments to the workflow, building simulation tools could also become an active driver in the development of the building design. As explained in the last part of section 2.3.3, the aim is to provide simulation-based design advice along with design implications. The design advice gives the designer the opportunity to make informed design decisions and thereby minimises time-consuming trial-and-error iterations. Therefore, a new subtask called 'parameter variation' is added. This subtask goes in the design iteration loop right after a potential rejection of a design proposal, see Figure 7.

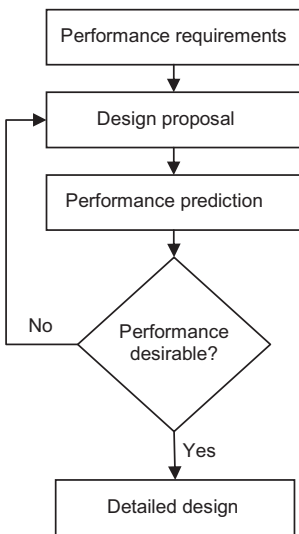

Figure 6. The workflow and subtasks in performance-based design.

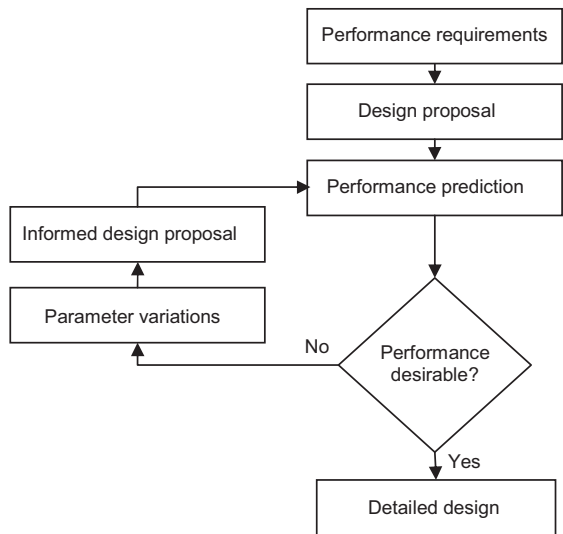

Figure 7. The proposed expansion of the workflow of performance-based design.

The workflow of Figure 7. works as follows:

- *Performance requirements* – The first task is to establish the performance requirements. The explicit definition of quantifiable performance requirements is the backbone of the performance-based design paradigm.
- *Design proposal* – The building designer generates an initial design proposal with focusing the spatial performance requirements.
- *Performance prediction* – The performance of the initial design proposal is predicted using the appropriate tool(s).
- *Performance evaluation* – The predicted performance of the initial design proposal is evaluated with respect to the performance requirements.
- *Parameter variation* – If the initial design proposal is not fulfilling the performance requirements, the proposal is used as a reference in the variations of performance-decisive parameters such as room and window geometry, component properties, etc.
- *Informed design proposal* – The parameter variations provide the designer with an overview of the consequences of adjusting a performance-decisive parameter prior to any actual design decision. With design decisions based on this overview, the new design proposal is more likely to fulfil the performance requirements in the following performance prediction and evaluation.

The workflow is repeated until a satisfying performance is reached. The workflow is operationalised in the iDbuild simulation program.

Adding the task of systematic parameter variations and using those as basis for design decisions may not be entirely novel to the design research community. But while this may be familiar to engineering and industrial design (e.g. Vincenti's Variation-Selection Model [63] and the Taguchi method [64]), the approach seems rarely used in relation to building design. The reason might be that its rational traits is not aligned with the prevailing notion of how buildings are (or should be) designed. Building design – or architecture – has been argued to follow a separate branch within the design discipline since the late 1960's, the so-called 'second generation' methods [28], which rejected the use of systematic and rational approaches in relation to architectural design (see section 2.1.2 for details). Even though research in architectural methods might develop in other directions today, one could suspect that the limited prevalence of more rational methods, such as 'performance-based design', is because the development of second generation methods have inherited certain scepticism towards rationality in architecture.

Bringing matters to a head, this could give rise to conflicts between the artistic architects and the rational engineers working on a common building project. However, it is not the intention of this research project to argue whether a building should be designed using a certain rational or artistic method but to stimulate a building design process which relies on a high degree of interdisciplinary collaboration (see section 2.1.4 for details). In this process different experts may make use different methods to generate their constructive input to the integrated design process.

It is in this relation that it is suggested that the engineer make use of the 'performance-based design' paradigm as it is illustrated in Figure 7.

3.3 The tool

The simulation tool iDbuild⁷ is developed to operationalise the workflow described in section 3.3. The first immediate issue was to identify an appropriate simulation 'engine'. The simulation tool BuildingCalc/LightCalc (BC/LC) [65] was chosen because it fulfils the following criteria:

1. *Few inputs and simple interface* – relatively few inputs and a simple interface facilitate the process of performing annual hourly-based simulations.
2. *Integrated energy and daylight performance predictions* – because daylight is important to energy performance as well as the quality of indoor environment.
3. *Rapid simulations* – a relative short simulation time for an hourly calculation (including hourly calculations of daylight levels) is important to the momentum of the initial design stages.

The major drawback of choosing BC/LC is its simplified algorithms. However, the validations of the tools suggest that their precision is sufficient for the initial stages of design. The precision of the thermal engine BuildingCalc is validated by Nielsen [65] by comparing heating and cooling demand with output from the sophisticated tool BSim [66]. The deviations are below 5% for all orientations. The precision of daylight engine LightCalc is validated by Hviid et al. [65] by comparing output with RADIANCE [36]. The deviations are below 6% for a clear glazing, below 8% for a lowered screen, and up to 35% for venetian blinds. The latter deviation is, however, on the conservative side: LightCalc calculates up to 35% lower illuminances than RADIANCE. This is due to the use of uni-directional light transmittances which could be remedied by using a more accurate characterization of the properties of complex shading devices. This issue is discussed further in section 6.3.

An alternative to the use of BuildingCalc/LightCalc was a tool based on more sophisticated algorithms, e.g. ESP-r [41] or EnergyPlus [46] coupled with RADIANCE [36]. However, this would have required a preliminary effort to condense input data, revise (or even make) interfaces and reduce simulation time before the three criteria above are fulfilled. By choosing BC/LC the research effort could be concentrated on assessing operability in relation to efficient application of parametric analysis and the usability of its output in real design projects (i.e. testing sub hypothesis 1 and 2, see section 1.2).

3.3.1 User interface

The user interface of BC/LC is developed to facilitate the suggested workflow in Figure 7., especially the parameter variation and informed design decisions tasks. This section is about the user interface.

⁷ iDbuild (or iDEEbuild) is an abbreviation for integrated/idealised/informed design of energy efficient buildings.

Table 2 is a list of the input data needed for a BC/LC simulation. The inputs are given as numerical values with the exception of glazing components which are chosen from a data base.

Table 2: Input parameters for iDbuild. These are also the performance-decisive parameters which can be included in parameter variations.

<i>Geometry</i>	<i>Constructions</i>
<ul style="list-style-type: none"> • Room depth • Room width • Room height • Overhang • Window width and height • Height of frame construction • Window orientation • Window position in façade 	<ul style="list-style-type: none"> • U-value of opaque constructions • Thermal capacity of constructions • Thermal capacity of interior • Thermal, solar and visual properties of glazing • Thermal properties of frame construction
<i>Systems and services</i>	<i>Energy supply</i>
<ul style="list-style-type: none"> • Internal loads • Lighting • Ventilation: <ul style="list-style-type: none"> - Mechanical - Natural - Infiltration • Thermal set points, cooling season • Thermal set points, heating season 	<ul style="list-style-type: none"> • Thermal efficiency of heating system • COP cooling system • Solar water heating • Photovoltaic • Specific Fan Power for ventilation • Energy for services • Hot water consumption

In iDbuild, a parameter variation can be defined as the variation of one single parameter or a bundle of multiple parameters. The definition of a single parameter variation is an input value from the initial design proposal ('Design proposal' in Figure 7.) and two user-defined variations. Performing a single parameter variation will show how the alteration of a single parameter affects the performance of the design. For some parameters, like window height and U-value of façade, it is recommended users set up a lower value and a higher value compared to the input value from the initial design proposal so that the output of the variation constitutes a tendency line giving the designer a wide solution space for an informed design decision. Figure 8 is an example of the input for a 'higher/lower' parameter variation. Other parameters, like glazing components, are characterised by a number of interdependent properties which make their performance behave discontinuously. The output of such a variation can only be given as single, independent values. Figure 9 is an example of the input for an 'interdependent' parameter variation.

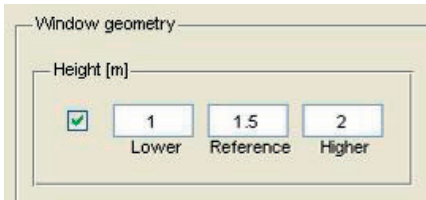

Figure 8: Setting up a 'higher/lower' parameter variation in iDbuild. The example shows that the window height is varied with +/- 0.5 m.



Figure 9: Setting up a 'interdependent' parameter variation in iDbuild. The example shows the variation of glazing component.

In some cases, it might be necessary to combine multiple input parameters to define a measure fully. An example is the introduction of night ventilation combined with increased thermal capacity as a mean to reduce energy for cooling. The combination of parameters can be bundled and treated as one single parameter variation. A bundled parameter variation will show how the bundle of input parameters as a combination affects the performance of the design. iDbuild will always perform three simulations if the bundled variation option is activated. For example, if the two parameters in Figure 8 and Figure 9 were bundled iDbuild would perform three simulations as in Table 3.

Table 3: Example of how the input from Figure 8 and Figure 9 would be combined in a bundled parameter variation.

Parameter	Window height	Glazing
Simulation 1 (Reference values)	1.5 m	4-15Ar-SN4
Simulation 2 (Var. 1 values)	1 m	4SN-12Ar-4-12Ar-SN4
Simulation 3 (Var. 2 values)	2 m	DbIskin 10-500Air-4-12Ar-SN4

3.3.2 Exploration, analysis and presentation of results

In relation to the suggested method, it is important that the simulation output from the parameter variations is easy to interpret. Prazeres [33] starts his detailed study on data perceptualisation techniques by identifying a number of issues which ought to be supported in the pre-processing of simulation output data:

- Exploration of performance data in a fully intuitive and interactive manner.
- Analysis of performance data through techniques that allow comparison of all design options at a glance.
- Presentation of performance data in an organised, structured and grouped manner.
- Targeted displays that depend on the user's technical/experience level (or background).

The first three issues are accommodated in the development of a performance overview for the

parameter variations performed in iDbuild. A more detailed explanation of this is given in this section. Figure 10 and Figure 11 are examples of what first meets the user of iDbuild in the exploration and analysis of the output from a parameter variation. Figure 10 is an example of the output from a 'higher/lower' parameter variation and Figure 11 is an example of the output from an 'interdependent' parameter variation (see section 3.3.1 for explanation of the two types of parameter variations). This is an attempt to give the user a full overview of the implications of the parameter variation in terms of energy performance, thermal indoor environment, indoor air quality and daylight. A detailed explanation of the performance indicators in the overview is given in the following.

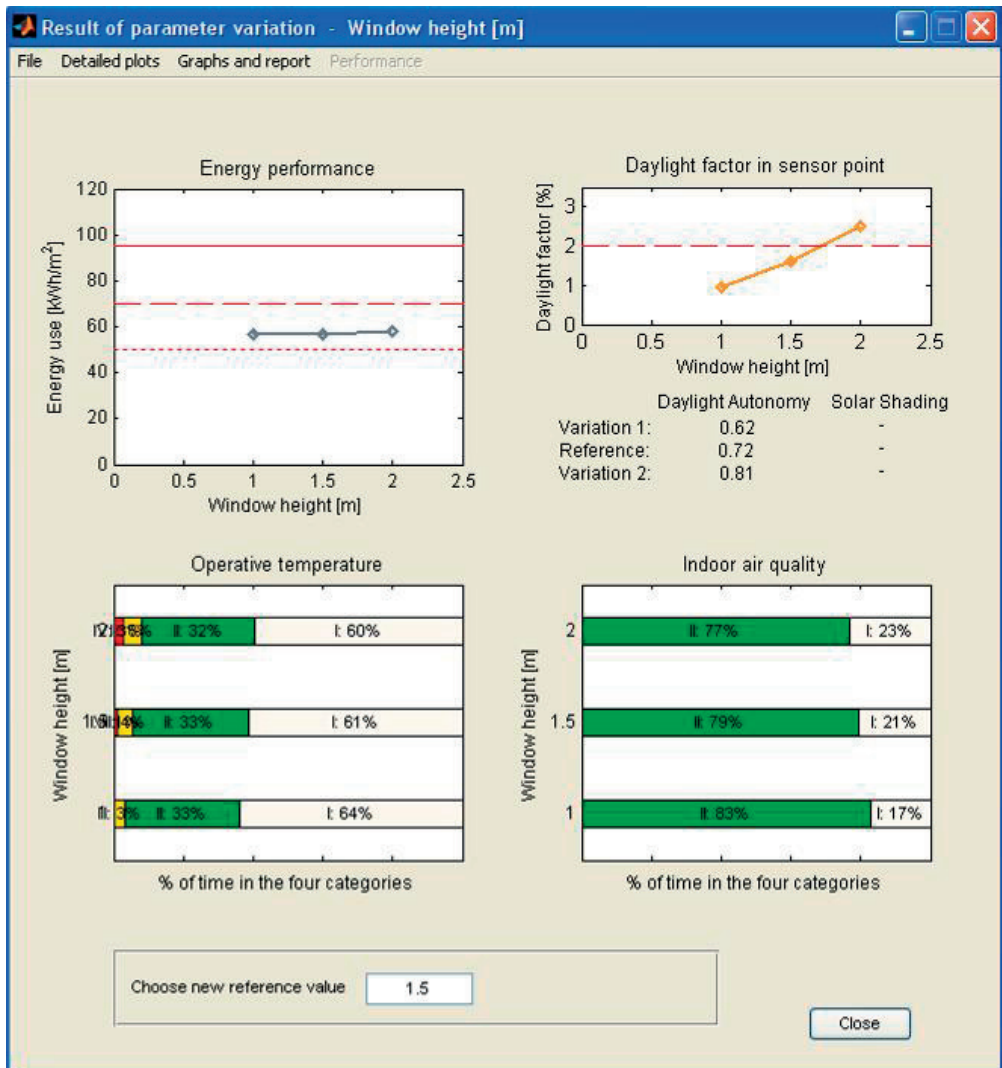

Figure 10. Performance overview of the variation of window height (a 'higher/lower' parameter). The user is able to enter an informed design decision in the bottom of the overview.

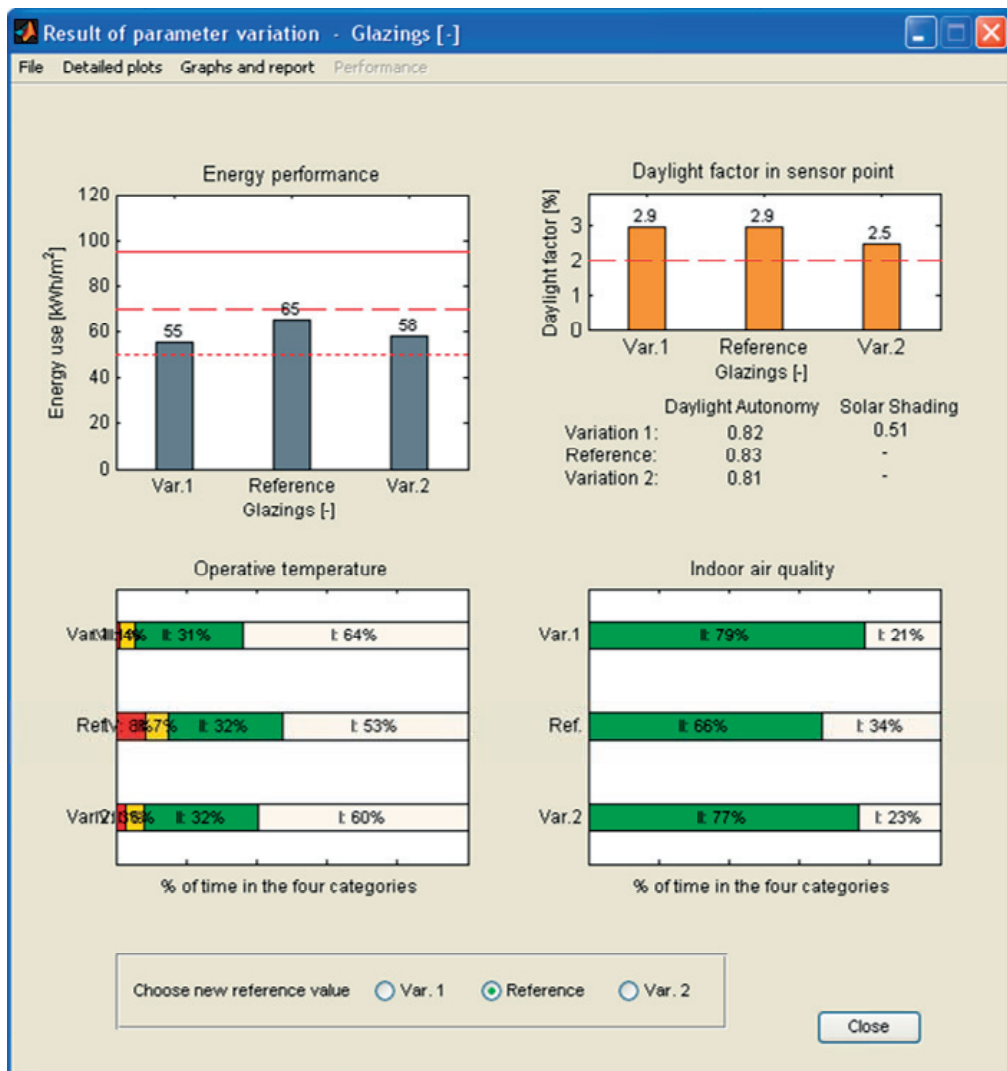

Figure 11. Performance overview of the variation of glazing component (a 'interdependent' parameter). Reference: Standard two-layer glazing with low-emission coating. Var. 1: Standard two-layer glazing with low-emission coating and external venetian blinds. Var. 2: Two-layer glazing with solar control coating. The user is able to enter an informed design decision in the bottom of the overview.

- *Energy performance (in the top left corner of the overview)*
Energy performance is assessed according to EPBD [4] and is therefore a sum of space heating, hot water heating and electricity for cooling, ventilation lighting and other services. All electricity consumptions are multiplied with a primary energy factor⁸ before added to the heating consumptions. Furthermore, solar heating and electricity produced on-site is subtracted.
- *Daylight performance (in the top right corner of the overview)*
The daylight performance can be assessed by the daylight factor measured in a user-defined point, the daylight autonomy⁹ in the same point, and by a factor indicating the fraction of annual time-in-use use where solar shading is active.
- *Thermal indoor environment (in the bottom left corner of the overview)*
The thermal indoor environment is evaluated according to the four categories of EN 15251 [5]. The four categories are indicated with colours. With the exception of the white class I colour, which is the preferable quality, the colour scheme works as a traffic light: green (class II) is acceptable, yellow (class III) is problematic, and red (class IV or out-of-category) is unacceptable. EN 15251 suggests that the annual quality of the thermal indoor environment is acceptable as long as only 3-5% of the occupied hours are in class III and/or IV.
- *Indoor air quality (bottom right corner of the overview)*
The quality of the indoor air is evaluated according to the four categories of EN 15251. The categories work just as for the thermal indoor environment.

The performance indicators can also be explored in detail. The energy performance can be presented split up in the individual types of energy consumption, see Figure 12. The thermal indoor environment can be explored in detail with respect to class I, II or III, see Figure 13. The daylight autonomy can be evaluated for different minimum illuminance levels and visualised, see Figure 14. An even more detailed level of result display is the graph plots containing the hourly values or duration curves, see Figure 15.

⁸ The primary energy factor is politically regulated and differs from country to country in the EU. For example, in Denmark it is 2.5, in Sweden 1 and in Germany 2.6 (in 2010).

⁹ The daylight autonomy is the percentage of occupied hours per year where the minimum illuminance level can be maintained by daylight alone.

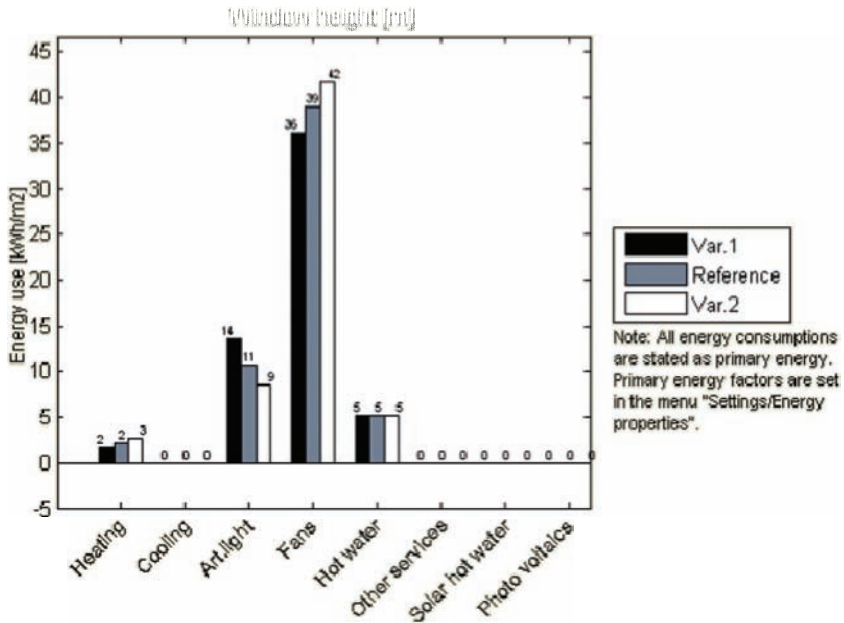

Figure 12. Detailed overview of the energy performance for the window height variation in Figure 10.

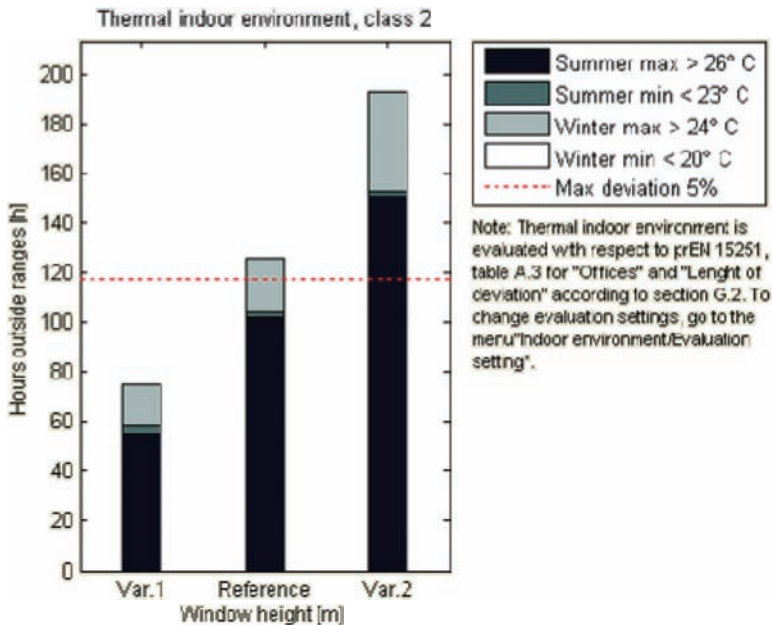

Figure 13. Detailed overview of the thermal indoor environment for the window height variation in Figure 10 evaluated with respect to class II. Reference is 1.5 m, Var. 1 is 1 m, and Var. 2 is 2 m.

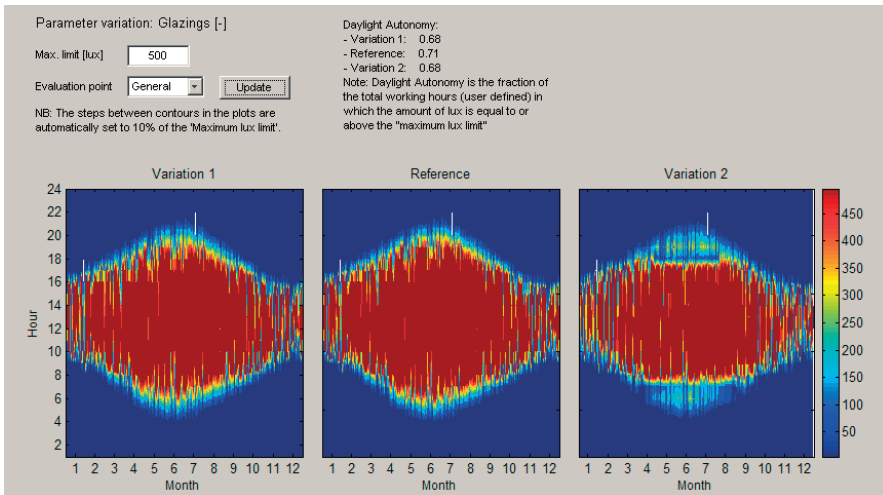

Figure 14. Analysis of the annual daylight performance for a parameter variation of the glazing components. Var. 1: 2-layers with solar control coating, Reference: 2-layers with low-emission coating. Var. 2: 2-layers with low-emission coating with external venetian blinds. The hourly daylight levels in lux are plotted for each month. The red areas indicate hours with a daylight level above 500 lux.

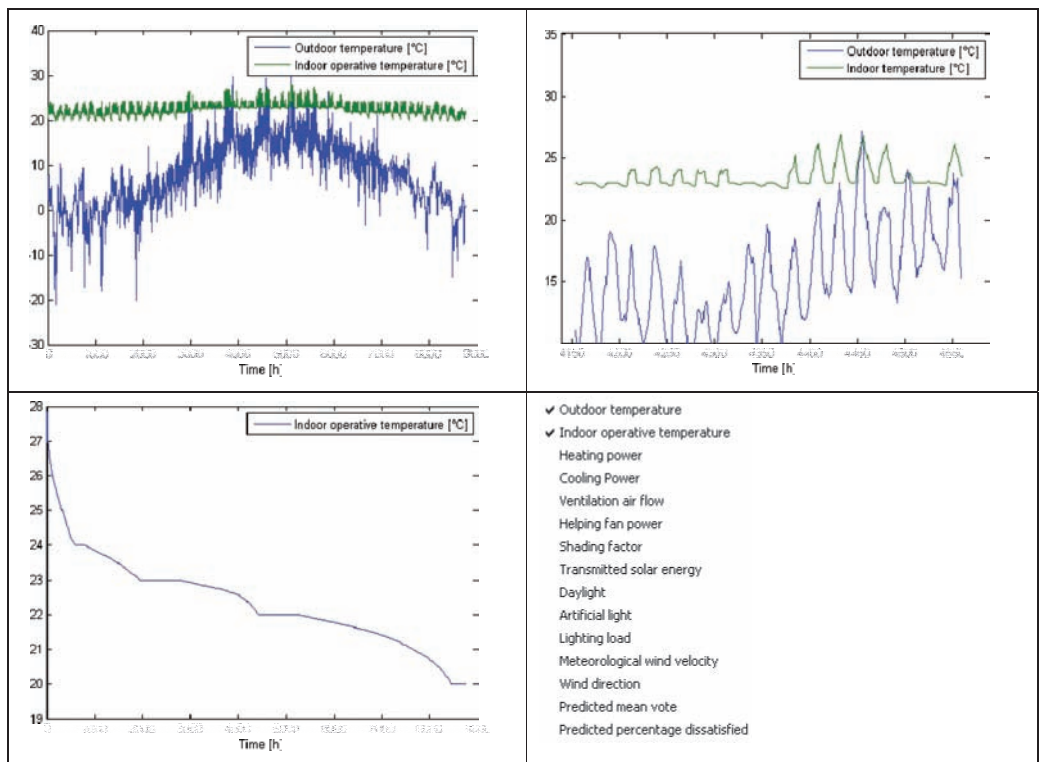

Figure 15. Detailed level of result display and analysis. Top left: Hourly data for entire year. Top right: Zoom-in on a week in July. Bottom left: Duration curve of indoor operative temperatures. Bottom right: List of possible hour plot parameters.

3.3.3 Facilitation of informed design decisions

The performance overviews in Figure 10 and Figure 11 also facilitate the 'Informed design proposal' task in the suggested workflow in Figure 7. The idea is that the user studies the performance overview and enters an informed design decision in the bottom of the overview, see Figure 10 and Figure 11. The user may make such a decision for each parameter variation performed. iDbuild automatically gathers the data from the informed design decisions and performs a new performance prediction including the design decisions. The performance overview for the new performance prediction is then used for evaluation. If the performance is undesirable the designer may make another design iteration by performing a new set of parameter variations, make informed design decisions, etc. This workflow can be repeated until a satisfying performance is reached.

3.4 The role of the tool in the building design process

The tool described in Paper I (see in appendix A) and section 3.3 is an attempt to operationalise the method described in section 3.1. Referring to 'the method and tool' therefore becomes somewhat of a pleonasm as a reference to 'the tool' could be an indirect reference to 'the method'. Therefore, henceforth 'the tool' will be the reference used. In this section the author provides reflections on the intended role of the tool in the overall building design process. Furthermore, comments from internationally recognised architectural designers on the proposed tool and its intended role in the building design process are discussed¹⁰.

The tool for generating simulation-based design support is developed for use in a design process based on interdisciplinary collaboration, e.g. like in the integrated design process (see section 2.1.4). It is recommended that the design support should be generated by the building energy expert in the design team. The reason is that the tool is considered an expert system and that efficient use of the tool therefore demands a certain level of knowledge e.g. regarding possibilities and limitations in building simulation. The building energy expert of a design team often has (or should have) access to several simplified as well as sophisticated simulation tools. In this 'pool of tools' the proposed (simplified) tool enables the expert to utilise the power of building simulation to generate design advice relatively fast compared to more sophisticated tools. The simulation expert could therefore benefit from using the tool in the initial stages of the design process.

The basic idea is that the simulation expert generates a range of possible room designs, using the tool described in this chapter, prior to the actual form giving of the overall building design. In the view of the author of this thesis, these room designs should be considered *design support*, i.e. one of many informative inputs to the integrated building design process. How the design support

¹⁰ Nigel Cross, a leading professor in design studies, mentions in ref. [25] five methods for research in design thinking. One of them, actually the personal favourite of Cross, is to perform interviews with designers who are acknowledged as having well-developed design abilities. In the view classic scientific research, such anecdotes are difficult to justify as real evidence but they are indeed recognised as a form of evidence in design research (i.e. design research as an independent culture, see section 2.1.3 for details).

is utilised in the integrated building design process is entirely up to the design group. One could imagine that the input is used indirectly, e.g. to update personal experience, or more directly, e.g. to help establish the overall architectural layout of the building. A more controversial use is that building designs are generated by combining the proposed rooms into a building.

The author of this thesis was fortunate to have the opportunity to discuss the tool and its potential role(s) in the building design process with a number of academics and design professionals. In one of these conversations the German architect Professor Thomas Herzog put forward the enigmatic statement when the talk fell upon a potential 'room before building' approach to building design: "*It is the question about the hen or the egg...*" Herzog's intention was of course to give no support to whether the building or its rooms should be designed first. What maybe can be derived from the statement is that good building design practice is to address both scales simultaneously. If so, the statement seems to support that the tool – and especially its output – could be a useful input to the overall building design process.

In another conversation about architect-engineer team work and the author's intention to make a simulation tool for fast generation of design support, the Danish architect Professor Jan Søndergaard got a notion of the tool as a 'high-tech slide rule', quote: "*There was a time when the cooperation between architects and the engineers was a dynamic process. The architects had paper and pen, the engineers had slide rules. Many suggested design options were discussed and evaluated, and by the end of the day a beautiful and buildable design was taking form. Then came a time where everything would stop at the first suggestion. Suddenly the engineer had to go home and calculate before making any conclusions. The next day – or week – the conclusions were presented but of course the architects had abandoned that idea and many others long ago. This was very frustrating times. With the emergence of these 'high-tech slide rules' we are getting back to the dynamic process. What a relief.*" The suggested tool could indeed constitute such a high-tech slide rule but the underlying point in the statement from Jan Søndergaard is more interesting: the architectural process is longing for competent sparring from engineers, and tools like the one described in this chapter might be a way forward. Such a statement enhances the motivation for initiating a more in-depth test of the tool, i.e. execute the hypothesis test described in section 1.2.

4 Operability of the tool

This chapter documents the research work related to the tests of sub hypothesis I: *It is possible to establish an operational tool for parametric analyses which can be used for generating input to the building design process.*

The research methodology to test *SH I* is described in detail in section 1.2.2 and is briefly summarised here. The initial aim of this research project was to propose a tool for generating simulation-based design support (see chapter 3 and Paper I in appendix A). But whether this tool is able to corroborate *SH I* relies on an analysis of the outcome from design projects where the proposed tool has been applied. The tool was therefore applied as a part of a master course at the DTU where a total of 67 student groups have used the tool to generate design support for an artificial building design project. The course ran four times within the four year period of the project. Each year the user feedback from the course and observations of the students working with the tool was used to test *SH I* and to identify possible improvements with the aim to further corroborate *SH I*. In these iterative tests special focus was given to the critical issue in relation to *SH I*, namely whether the tool can be designated 'operational'.

4.1 Iterative test of tool in master course

Using the tool for generating design support for the early stage of an artificial building design project was the main theme in one of two subtasks for a master course in 'Building energy and technical services – integrated design' at DTU. The official course description can be found in appendix B. The benefit from this test environment (the master course) was that it enabled the isolated study of the interaction between the users (students) and the tool, and the comparison of different teams working on the same problem. The subtask was a part of the course in four consecutive years (2006-2009). Every year the data gathered by the author as an *overt observing participant* and the feedback (self-observations) from the students was analysed, 1) to test *SH I* and 2) to identify initiatives which in any way could improve the tool. Furthermore, the data could also suggest ways to improve the communication of the purpose of the tool and its output. This way the tool and communicative issues regarding its purpose was developed in an iterative, evidence-based manner with the aim to improve the corroboration of *SH I*.

4.1.1 Description of the artificial building design project

The design brief for the artificial building design project was virtually the same each year. The students were told that they should imagine that they were hired by the Technical University of

Denmark (DTU) together with a group of architects to build a new building for the Department of Civil Engineering. The client (DTU) gave the following initial information and basic requirements:

- *Users:* Staff and students at the department
- *Building site:* Open field – no significant shading from surroundings.
- *Client needs:*
 - Offices for 180 scientific and administrative personnel – single person offices.
 - 40 working rooms for thesis project work - two workplaces per room.
 - Rooms for teaching: 1 auditorium for 200, 3 auditoria for 80, 15 seminar rooms for lectures and exercise for 40 students, sitting at tables with portable PC's.
 - Rooms for archives and servers in the basement under the building.
- An energy performance of *at least* low-energy class 1 according to the Danish Building Code¹¹.
- The indoor environment must mainly be at least in class II in EN 15251 [5] for all performance issues – 5% deviation allowed.
- Office hours are from 8-17 except weekends.
- Seminar rooms are only used from 8-12 and again from 13-16 except weekends. No lectures in July and August.

For the first subtask of the course, the students were divided in groups of two and asked to focus on generating three alternative room designs of the single person office for scientific and administrative personnel and of the 40 person seminar room. The reason for asking the students to make design proposals for two different functions is to make a broader examination of the usability and operability of the tool. If the students were asked to make design proposals for only one function, then it would only be possible to conclude whether *SH I* holds for generating design proposals for this certain function. It was estimated that the assignment could be executed within a total of 9 hours per week for five weeks, including weekly lectures lasting two to four hours.

In the second subtask of the course, the students should choose a single room design from the first subtask and use it as starting point for more detailed performance analyses in the more sophisticated simulation tool IES Virtual Environment [67]. The subtask simulates the type of analysis needed in the more detailed design stages. The experiences and outcome from this subtask is therefore not involved in this thesis because focus is on the iterative development of a tool fit for informing the early design stage.

4.1.2 Gathering data from the student projects

The purpose of the student project in relation to the research reported in this thesis was to gather data for the test of *SH I*. The assignment description should therefore prepare the ground for the gathering of relevant data. The aim of this section is to describe the rationale behind the

¹¹ In low energy class I the maximal allowed amount of energy delivered to the building is 50 kWh/m² per year (stated as primary energy) for heating, cooling, ventilation, hot water and lighting.

formulation of assignment text so it is made clear how the conducted student project provided relevant data for the test of *SH I*.

The following is a resume of what the students had to deliver in a report documenting their work. Besides accommodating certain formalities (the inclusion of an abstract, introduction and references to the course material, maximum number of pages, etc.), the report should contain the elements following this paragraph. The rationale of each element in relation to the underlying purpose of the student projects, namely to test *SH I*, is given in continuation of each element. Furthermore, a description of the gathered data and the treatment of the same are given.

1. Present three alternative room designs of the single person office and the 40 person seminar room fulfilling the basic requirements of the design brief.

Rationale: The alleged useful design support, i.e. the output from the tool, is proposals for room designs fulfilling certain demands. Whether the students were able to generate a number of alternative room designs is therefore considered a measure for whether the tool is operational or not. This element of the student reports is thus important for testing the prediction of *SH I*.

Data: The number of rooms fulfilling the basic requirements each group managed to design – single office as well as seminar room – is recorded. Based on this data, the different rates of success is calculated:

- The total rate of success – the percentage of groups who managed to fulfil the assignment completely, i.e. design three design proposals fulfilling the basic requirements for each function¹².
- The rate of success, office – the percentage of groups who managed to design three design proposals for the office.
- The rate of success, seminar room – the percentage of groups who managed to design three design proposals for the seminar room.
- The partial rate of success, office and seminar room – according to Nielsen [68] it is unreasonable to give the same score (zero) to both users who did nothing and those who successfully completed a part of the task. He instead argues for granting partial credit for a partially successful task – a score depending on the magnitude of user error. Therefore, the number of rooms the groups who did not manage to design three offices and seminar rooms, respectively, forms a partial rate of success. In this relation, one room successfully designed counts as 1/3 of success.

¹² This metric says nothing about 'why' the students fail or 'how well' they perform. However, this may be identified by studying the more qualitative feedback from the students and the data recorded through the participant observation.

The data described above data may be used to analyse how consistently the students operate and thus being useful in the assessment of the usability/operability of the tool.

2. State any pros and cons in relation to the tool based on your own experience from working on the assignment. Provide any suggestions for improvements of the tool, and/or suggest alternative approaches which might contribute to the implementation of design low-energy buildings with high quality of indoor environment.

Rationale: According to the SER model described in section 1.2.2, software systems must evolve at the hands of the users since users (not developers) experience a system's deficiencies. The students have in the assignment worked quite a lot with the tool, and it is therefore obvious to ask the students to point out any deficiencies that they may have experienced. This feedback is valuable in terms of testing *SH I*: it may indicate suggestions for improvements to the tool that may lead to further corroboration of *SH I*.

Data: Statements and suggestions from students. This data may directly point out any deficiencies (e.g. program bugs and inexpedient setup of user interfaces). Furthermore, it may identify reasons for 'why' some students fail, and 'how well' they perform in general.

3. The students were asked to fill out a questionnaire as a part of the course evaluation. Here, they were asked to state how much time they spent on the assignment compared to the expected amount of time (nine hours per week) and whether they felt that they had sufficient academic prerequisites to execute the assignment.

Rationale: Minimising time consumption for generating the design support is considered key in terms of whether the tool is considered operational or not. The use of the tool must not be perceived as an exercise 'that slows down the overall building design process'. Therefore, the energy expert of the design team should use as little time as possible to establish the design support. Whether the students felt that they had sufficient academic prerequisites is important to assess whether any deviations in the annual student feedback could be ascribed different academic prerequisites.

Data: Data indicating whether the students were spending too much time on the assignment, and the self-evaluation of their academic prerequisite.

4.1.3 Gathering data through observations

Besides the data provided in the student reports, described in section 4.1.2, data was also gathered through observations of the students working on their assignment. The purpose was to identify any latent issues in relation to the practical use of the tool, i.e. issues that may be the underlying cause for deficiencies pointed out by the students, 'why' some students fail to fulfil the assignment, and 'how well' they perform in general. But gathering objective data through observations is not unproblematic. Experiences from other research areas may, however, provide some insights on how to gather genuine data through observations.

The following paragraph of this section is reformulated renderings from the educational book 'Central Issues in Sociology' by Hugh Chignell [69]. The book contains, among other issues, descriptions of different observational techniques. Observation is a fundamental method to gather first hand information in sociology, and is especially common and accepted when studying sociology of education. Therefore, the research area has much experience on how to properly observe persons in educational settings. Generally seen, observational technique is divided in two: 1) participant observation where the researcher contributes to a group's behaviour, and 2) nonparticipant observation whereby the researcher remains inconspicuous as a "fly on the wall". Furthermore, both participant and nonparticipant observations can be either overt (open) or covert (secret). There are pros and cons of the four different observational techniques but sociologists often take a pragmatic approach and use whichever method is suitable for a certain purpose or whatever the research subjects and circumstances allows.

The observational technique used in the master course is best described as 'overt participant observation'. 'Overt' because the students were aware of the fact that they were observed, and they were informed about the purpose, scope and approach of the research (i.e. the iterative development and test related to *SH I*), and 'participant observation' because the author also had the role as teacher and supervisor thus eliminating nonparticipant observation.

This technique was regarded as the most suitable taking into consideration the overall framework of the research project and the pros and cons of different observational techniques. The advantage of overt participant observation in relation to the research of this thesis is 1) the accepted presence of the researcher and openness makes access to the students' domain easy and avoids a number of ethical issues which is present when being covert¹³, and 2) the fact that the researcher is involved and is studying the students in an open way means that it is relatively easy to generate and record data – especially in comparison to covert participant observation where the research subjects would become suspicious if you record data openly. The disadvantages are 1) the so-called 'Hawthorne effect' [70] (or 'observer effect') where the behaviour of those under study may alter due to the presence of the researcher, and 2) the risk of recording interpreted data (one could imagine that the researcher, consciously or unconsciously, is seeking a certain answer and is therefore interpreting observations in a certain way) is more distinct compared to covert observation because the researchers' objectivity risks being affected

¹³ In covert observations the researcher is in fact spying on people and therefore risks breaching the right of privacy for the individual in cultures which value this.

by the personal interaction with the research subjects. The effects of these disadvantages are, however, not considered significant in this research project. The reason is that underlying basis for the observations, i.e. the test environment and overall assignment description, were the same each year. This enabled the researcher, all things being equal, to record the relative effect of improvements to the tool for use in the test of *SH I*.

4.1.4 Iteration 1

The first iteration took place in the fall of 2006 where a total of 13 groups (28 students) were attending the master course.

4.1.4.1 Developmental stage of the tool

The first version of the tool was quite 'manual'. The tool was generating an output in .txt format containing model information and hourly values for energy needed for heating, cooling and lighting, ventilation rates for natural and mechanical ventilation, and the operative temperature. This data was then copy/pasted into an Excel spreadsheet which was able to convert the data into kWh/m² per year according to the Danish building regulations [71] and evaluate the thermal indoor environment and air quality according to EN 15251 [5]. To make a parameter variation as described in section 3.3.1, the students had to go back to the interface of the tool, change a parameter, run the simulation again, and copy/paste the result into the spreadsheet – and then repeat to have a 'lower value (var. 1) / reference value / higher value (var. 2)' parameter variation. The output from the early version of the tool is shown in Figure 16. The flexibility of the spreadsheet was quite limited as it was only able to evaluate the indoor environment in a fixed interval for occupied hours and had a fixed definition of summer and winter period.

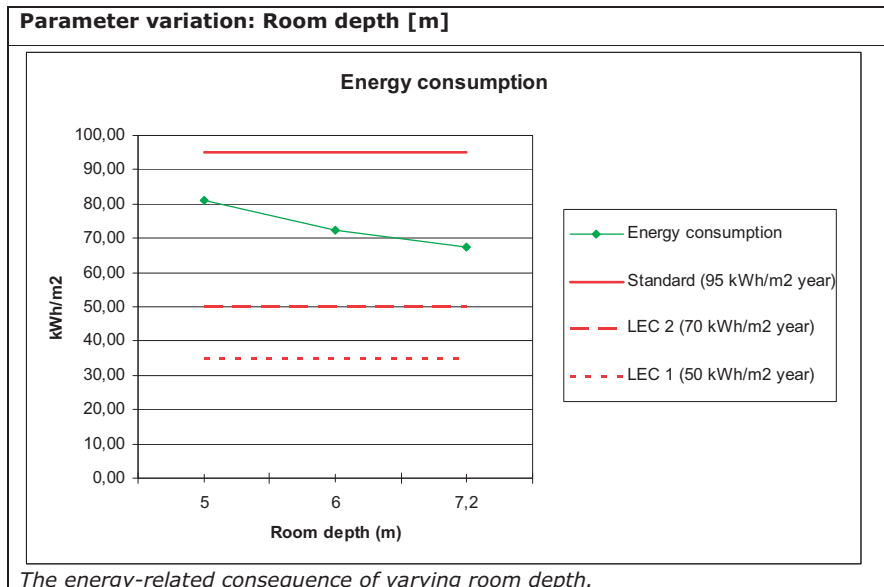

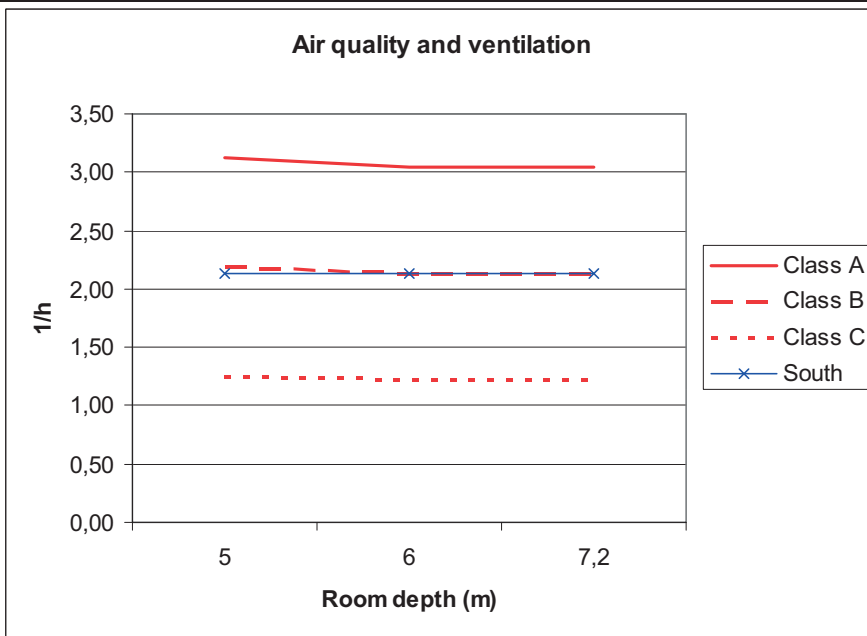

The consequence in terms of air quality when varying room depth.

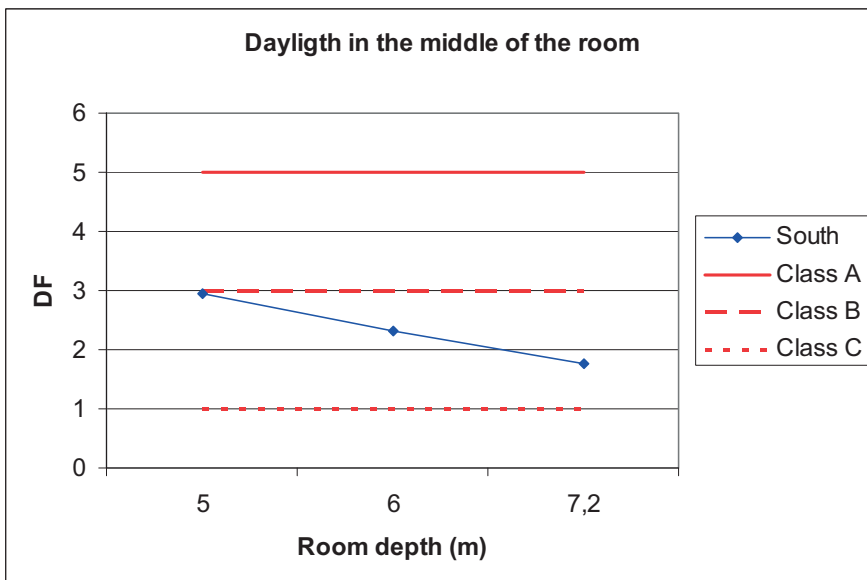

The consequence in terms of daylight when varying room depth.

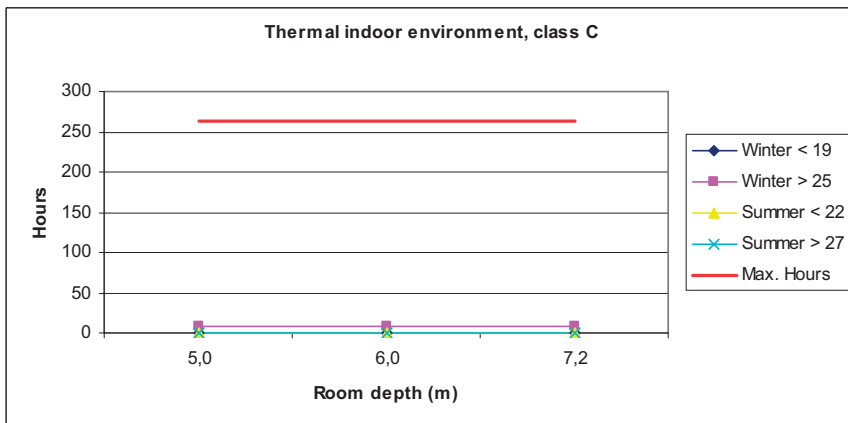
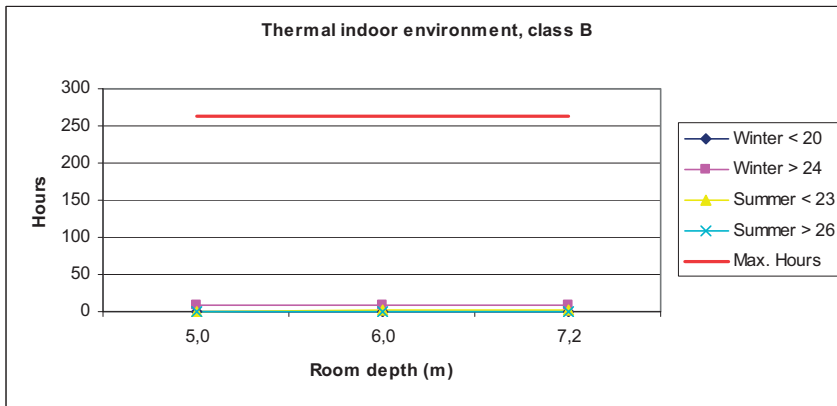
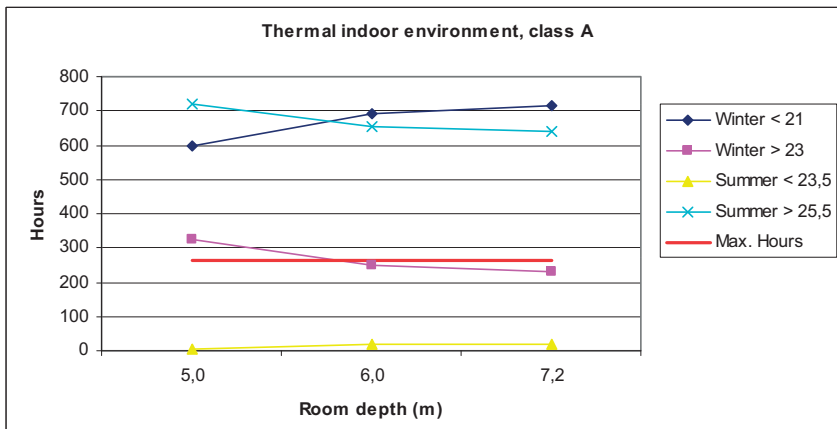

The consequences in terms of thermal indoor environment when varying room depth (for class I, II and III, respectively).

Figure 16. Output from an early version of the tool (2006). The result of a parameter variation was manually generated by copy/pasting simulation results in to an Excel spreadsheet.

The idea was that students should make informed design decisions by studying the output from the spreadsheet and produce their reports with the content described in section 4.1.2.

4.1.4.2 Data from student reports

The structure of the presentation of the data collected from the student reports is given according to the four points listed in section 4.1.2.

Issue 1: The number of rooms fulfilling the basic requirements

The number of groups who managed to design three, two, one and zero room designs for the two different functions (office and seminar room) is shown in Figure 17. The raw data and individual comments to each student report can be found in appendix C. Table 4 provides the students' rate of success.

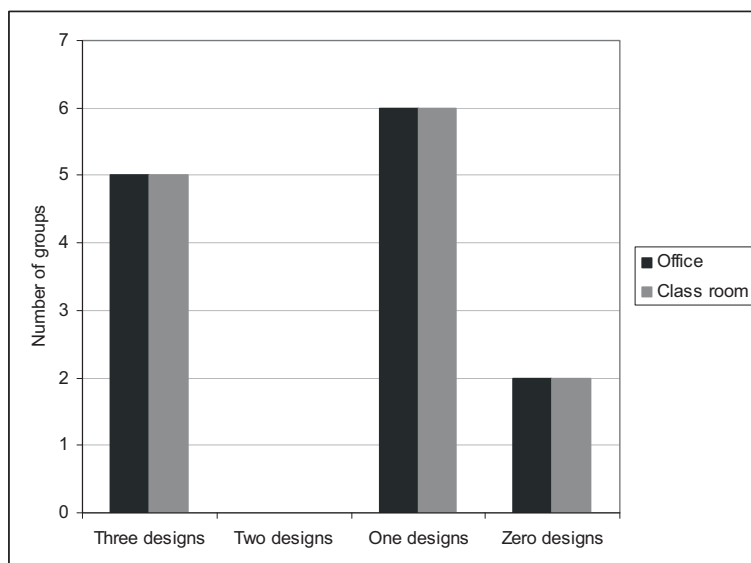

Figure 17. The number of groups who managed to design three, two, one and zero room designs for the two different functions (office and seminar room) in 2006.

Table 4. Rate of success, fall 2006

Function	Rate of success	
	Absolute	Percentage
Total rate of success	5 groups out of 13	38 %
Rate of success, office	5 groups out of 13	38 %
Partial rate of success, office	6 rooms out of 39*	15 %
Rate of success, seminar room	5 groups out of 13	38 %
Partial rate of success, seminar room	6 rooms out of 39*	15 %

*6 rooms out of 39 possible (if all groups had designed three rooms: 3x 13 groups = 39)

Issue 2: Student statements about pros and cons

The following statements were given by the students in their reports.

Student appreciations:

- Interesting and relevant assignment.
- Making parameter variations helps to understand the relation between parameters and performance.

Student criticism:

- Long waiting time due to long simulation time.
- Making parameter variations with the tool is a time-consuming process.
- Difficulties in interpretation of simulation output in the Excel spreadsheet graphs.
- Tool limitation: Only one window in one façade, and only rectangular rooms.
- Concerns that the analyses input would “constrain architectural freedom” and/or lead to “boring building designs”.

Issue 3: Academic prerequisites and time spent on the assignment

Data collected from the course evaluation is given in the following.

Academic prerequisites

Answer percentage: 61 %
(17 out of 28 students)

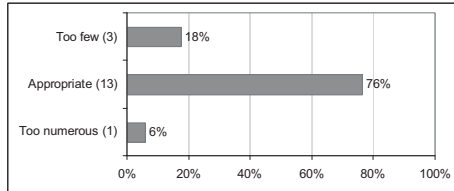

A total of 82 % of the students answering felt they had sufficient academic prerequisites.

The amount of time spent on the assignment (i.e. more than nine hours per week)

Answer percentage: 64.3 %
(18 out of 28 students)

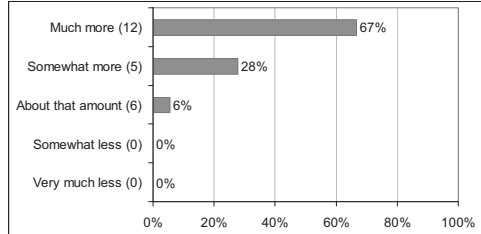

A total of 94 % of the students answering felt they had used more time than expected.

4.1.4.3 Data from observations

The following was recorded during the observation of the students working on the task:

- Frustrations expressed regarding simulation time which was considered too long (7.2 min per simulation¹⁴).
- Simulation models often corrupted by invalid input especially when comma (,) was used instead of dot (.).

¹⁴ Simulation time measured for the 18 m² office described in Paper I using a laptop with a Pentium M processor running at 1.86 GHz and 2 GB of RAM.

- Wrong setup of simulation model in relation to what the Excel spreadsheet was able to evaluate (e.g. occupied hours).
- Lack of basic Excel skills.
- Problems with copy/pasting the data correctly to the Excel spreadsheet. Data was often corrupted because Matlab operates with dot (.) as separator whereas the Danish version of Excel uses comma (,).
- Difficulties in interpretation of simulation output thus making appropriate design decisions.
- Problems establishing even one room design fulfilling the basic requirements. Much time used on simulating measures which had no or little effect on performance.

Additional observations from assessment of student reports:

- Very few use illustrations to communicate their results. Instead they describe their designs in numerical terms, e.g. "the room dimensions are 3 x 5 x 2.8 m".
- All of the groups who only designed one room per function (6 out of 13 groups, see Figure 17) used the output from parameter variations to optimise one solution instead of generating a range of possible room designs.

4.1.4.4 Test of *SH I* and suggestions for improvement

In this section the data from the previous sections is used for testing *SH I*: *It is possible to establish an operational tool for parametric analyses of the energy performance and indoor environment which can be used for generating input to the building design process.*

The keyword in *SH I* is '*operational*'. A rate of success of 38 % and a rate of success incl. partial success of 54 % for both room functions indicates that it is indeed possible to establish a tool for generating the sought output (proposals for room designs).

The relatively low rates of success, however, indicate that the operability issue of *SH I* is difficult to support. The main reason for the low rate of success is that a large fraction of the student groups (46 %) misinterpreted the purpose of the assignment and used the tool for optimising a single solution for each function instead of generating a number of possible solutions. However, ruling out this misinterpretation, the fact is that the vast majority of the students experienced a high rate of model corruption, long simulation and process time, and difficulties in the interpretation of simulation output. The observations of the students working on the assignment furthermore identify that too much time is used on simulating measures which have no or little effect on performance. This leads to the realisation that the tool at this developmental stage is relatively poor in terms of operability. It is therefore difficult to argue that the tool is operational in a broad definition.

The rate of students who felt that their academic prerequisites were sufficient to solve the assignment is 82 %. This issue was therefore not an immediate hindrance in terms of solving the assignment. This was in general confirmed by observing the students working on the assignment.

The overall conclusion is a partial corroboration of SH I because data indicates that it is indeed possible to establish a tool for generating the sought output (proposals for room designs), but that the tool at its developmental stage has a quite limited operability.

Processing the data from the student reports and the data from observations gives rise to the actions for improvements in Figure 5 before the tool is used again in the fall 2007.

Table 5. Issues experienced when testing the tool, and suggested actions for improvements (fall 2006).

Issues	Actions for improvement
Difficulties in interpreting and using the simulation output.	Major revision of result analysis and display. The Excel spreadsheet is abandoned. Instead the output treatment and display is integrated as a part of the tool.
Time consuming process to generate parameter variations	New user interface developed to facilitate the parameter variation.
Simulation time considered too long (7.2 min per simulation).	Improvements of the LightCalc algorithm.
Simulation models often corrupted by invalid input.	Implementation of error messages in the tool.
Problems establishing even one room design fulfilling the requirements.	Providing the students with various parameter analyses illustrating the relative importance of the different parameters. The aim is to give the students some insight which they can use to establish a reference room (a starting point for the parameter variations) fulfilling the basic requirements.
Misinterpretation of the purpose of the assignment (tool used for optimising a single solution for each function instead of generating a number of possible solutions)	Emphasis on better communication of the purpose of the assignment and tool in lectures (i.e. to generate design support in the form of 2x3 proposals for room designs).
Very few use illustrations to communicate their results.	Explicit demand in the assignment text for illustrations (drawings) of solutions.

4.1.5 Iteration 2

The second iteration took place in the fall of 2007 where a total of 13 groups (25 students) were attending the master course.

4.1.5.1 Developmental stage of the tool and other initiatives to improve operability

The second major version of the tool was very different from the version used in 2006. First of all, a new user interface was developed to facilitate the process of making parameter variations. A parameter variation could now be defined directly in the tool, as shown in Figure 18, and be generated automatically without any additional user actions. For further detail on the rationale behind the definition of parameter variations, see chapter 3 and paper I in appendix A.

The new user interface also enabled user-defined intervals for occupied hours and definition of summer and winter period.

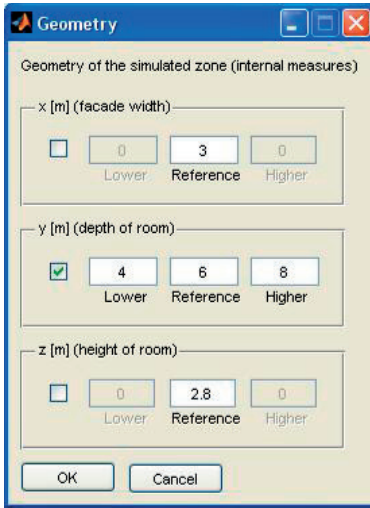
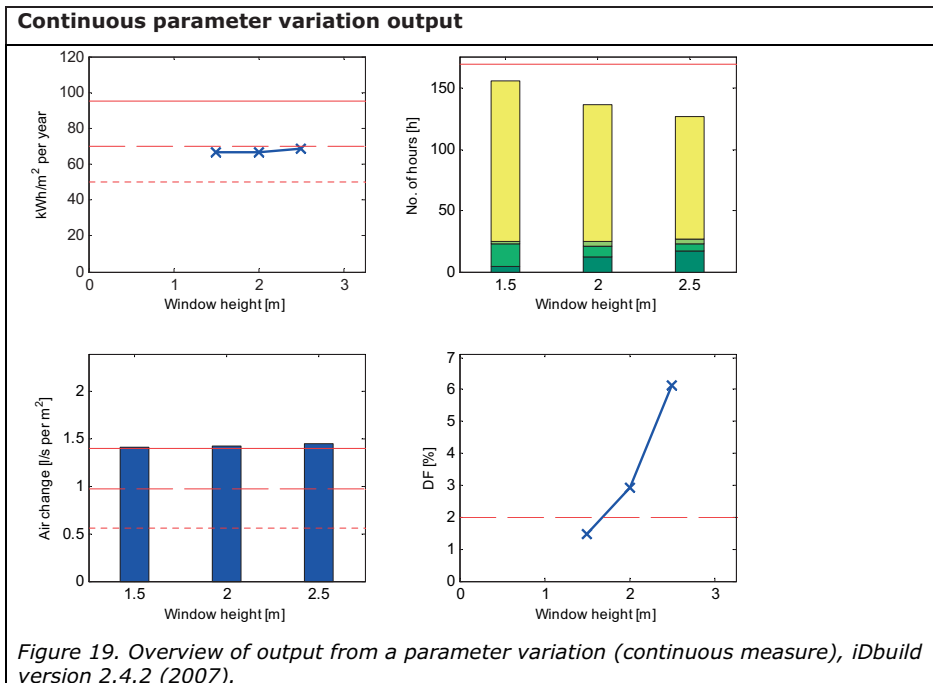

Figure 18. Example of new user interface for facilitation of parameter variations. The example shown is the interface for room geometry where a variation room depth is defined.

The output treatment and display of a parameter variation was also integrated as a part of the tool, eliminating all the problems occurring when copy/pasting output into an Excel spreadsheet. Furthermore, the intention was to improve the interpretation of the output. Examples of the new output are shown in Figure 19 and Figure 209.



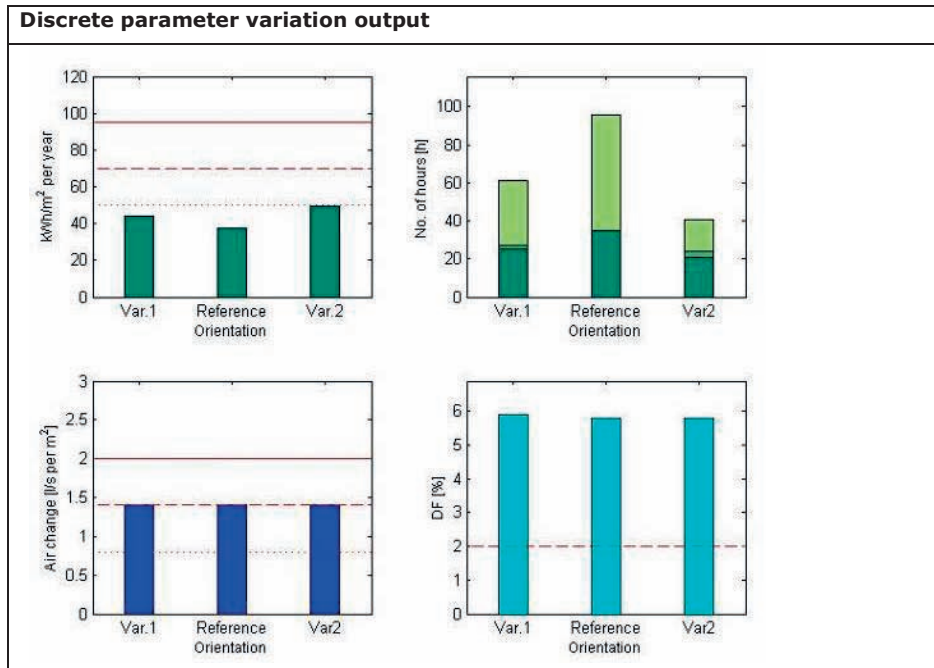

Figure 20. Overview of output from parameter variation (discrete measure), iDbuild version 2.4.2 (2007).

The implementation also included a number of error messages with the aim to avoid that models were corrupted by invalid user input, and some code improvements to speed up the LightCalc algorithm, thus reducing simulation time.

Besides the tool-related changes, the students were also provided with various parameter analyses illustrating the relative importance of the different parameters. The aim was that the students would reduce time consumption for the establishment of a good starting point for the parameter variations, i.e. a room fulfilling (or nearly fulfilling) the basic requirements, by using these parameter variations as inspiration. Furthermore, more time was used in the lectures of the master course to put emphasis on the purpose of the assignment and tool, i.e. to use the tool for generating design support to the overall building design process in the form of 2x3 proposals for room designs.

4.1.5.2 Data from student reports

The structure of the presentation of the data collected from the student reports is given according to the four points listed in section 4.1.2.

Issue 1: The number of rooms fulfilling the basic requirements

The number of groups who managed to design three, two, one and zero room designs for the two different functions (office and seminar room) is shown in Figure 21. The raw data and individual comments to each student report can be found in appendix C. Table 6 provides the students' rate of success.

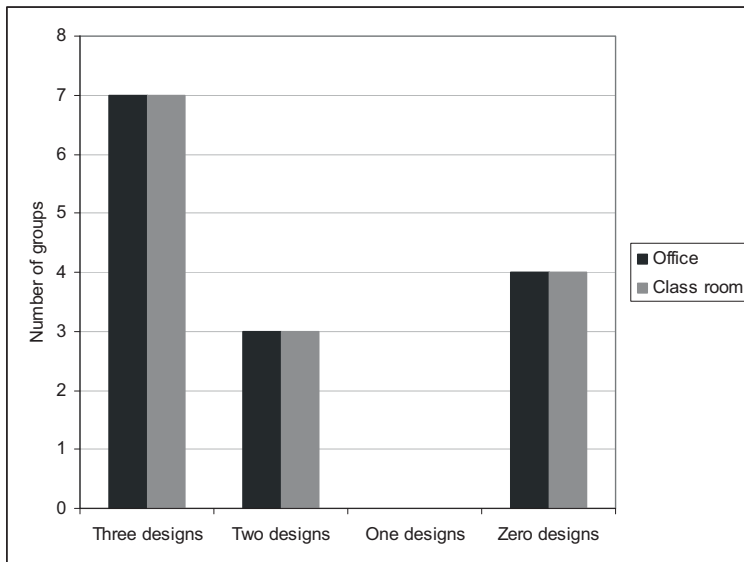

Figure 21. The number of groups who managed to design three, two, one and zero room designs for the two different functions (office and seminar room) in 2007.

Table 6. Rate of success, fall 2007

Function	Rate of success	
	Absolute	Percentage
Total rate of success	5 groups out of 13	47 %
Rate of success, office	7 groups out of 13	54 %
Partial rate of success, office	4 rooms out of 39*	10 %
Rate of success, seminar room	7 groups out of 13	54 %
Partial rate of success, seminar room	4 rooms out of 39*	10 %

*4 rooms out of 39 possible (if all groups had designed three rooms: 3x 13 groups = 39)

Issue 2: Student statements about pros and cons

The following statements were given by the students in their reports.

Student appreciations:

- Our solutions give a wide range of possibilities for the architect to design a building that abides the design parameters set for this task.
- Interesting experiment and a good training in design of sustainable buildings.

Student criticism:

- Long waiting time due to long simulation time.
- Making parameter variations with the tool is a time-consuming process.
- Tool limitation: Only one window in one façade, and only rectangular rooms.
- Program bugs interrupting the process.
- The possibility to make a more detailed evaluation of energy performance.
- A few groups expressed concern that the input would “constrain architectural freedom” and/or lead to “boring building designs”.

Issue 3: Academic prerequisites and time spent on the assignment

Data collected from the course evaluation is given in the following.

Academic prerequisites

Answer percentage: 59.3 %
(16 out of 27 students)

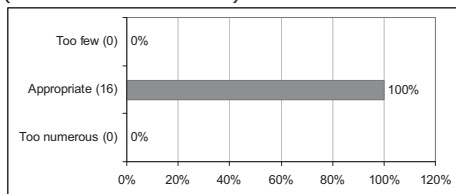

A total of 100 % of the students answering felt they had sufficient academic prerequisites.

The amount of time spent on the assignment (i.e. more than nine hours per week)

Answer percentage: 59.3 %
(16 out of 27 students)

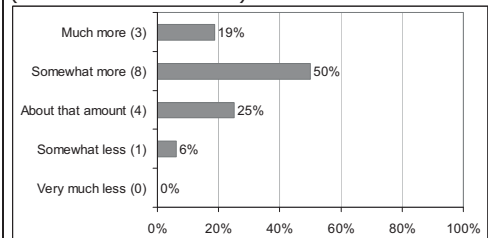

A total of 69 % of the students answering felt they had used more time than expected.

4.1.5.3 Data from observations

The following was recorded during the observation of the students working on the task:

- Frustrations expressed regarding simulation time which was considered too long (6.8 min per simulation¹⁵).
- Program bugs in the user interface were interrupting the process.

¹⁵ Simulation time measured for the 18 m² office described in Paper I using a laptop with a Pentium M processor running at 1.86 GHz and 2 GB of RAM.

- Problems establishing even one room design fulfilling the basic requirements. Especially the task of setting up appropriate control of building services seems difficult.
- Providing various parameter variations as inspiration for establishing a good starting point for the parameter variations had in general only a little effect on the time used. Many groups chose to "find it on their own".
- Still some difficulties in terms of interpreting the output, especially the air change graph.
- All design decisions made based on parameter variations need to be put into a new model to be evaluated as a whole. This manual process is quite time consuming.
- A few groups had problems working with the fact that they had to make simulations without having an overall building geometry in front of them. They felt that there was too little information to make simulations.

Additional observations from assessment of student reports:

- All of the groups who designed zero rooms (4 out of 13, see Figure 21) misunderstood the assignment. They made a range of parameter variations but did not use them for designing rooms.
- Two groups used the tool as intended, and did not indicate that they used an excessive amount of time.

4.1.5.4 Test of *SH 1* and suggestions for improvement

In this section the data from the previous sections is used for testing *SH 1: It is possible to establish an operational tool for parametric analyses of the energy performance and indoor environment which can be used for generating input to the building design process.*

The rate of success rises from 38 % in 2006 to 47 % and the rate of success incl. partial success rises from 54 % to 64 % for both room functions. This strengthens the indication from *iteration 1* that it is indeed possible to establish a tool for generating the sought output (proposals for room designs).

The rise in the rates of success indicates that the operability issue of *SH 1* is strengthened compared to 2006. The rise is mainly ascribed the fact that the students did not express any difficulties in terms of setting up a parameter variation and interpreting the output, and consequently had more time to focus on the core of the assignment (namely the establishment of proposals for room designs). This is also reflected by a drop from 92 % to 69 % in students responding 'yes' to whether excessive time was used on the assignment. The rise in the rates of success and the fall in excessive time used is considered an indirect result of the efforts of establishing a new user interface to facilitate the process of making parameter variations, and integrating the handling of output in the program. But even though the rates of success are rising, the rates are still considered too low to fully corroborate *SH 1* in terms of operability. One of the reasons for the relatively low rates of success is that a fraction of the student groups (21 %) misinterpreted the purpose of the assignment and made a range of parameter variations without using them for generating proposals for room designs. Ruling out the groups who misunderstood

the assignment would result in substantially higher rates of success (78 % and 93 % incl. partial success for generation of offices and seminar rooms, respectively). However, even though this indicates that there is a rise in operability of the tool, there is still a range of issues pointed out by the students which (when improved) may improve the operability. It is the general notion that the simulations take too long, and that there are too many program bugs. Furthermore, the observations of the students working on the assignment show that the various parameter analyses illustrating the relative importance of the different parameters did not reduce time consumption for the establishment of a good starting point for the parameter variations.

The rate of students who felt that their academic prerequisites were sufficient to solve the assignment was 100 %. This issue was therefore not an immediate hindrance in terms of solving the assignment. This was in general confirmed by observing the students working on the assignment.

The overall conclusion is that the data indicates a mild corroboration of SH I. The reasons are 1) that data indicates that it is indeed possible to establish a tool for generating the sought output, and 2) that the tool has demonstrated a nascent operability due to the fact that two groups managed to use the tool as intended and deliver a result within an acceptable time frame. However, an overall assessment of the data gives no evidence to support that the tool is operational in a more broad definition.

Processing the data from the student reports and the data from observations give rise to the actions for improvements in Figure 7 before the tool is used again in the fall 2008.

Table 7. Issues experienced when testing the tool, and suggested actions for improvements (fall 2007).

Issues	Actions for improvement
Simulation time considered too long (6.8 min per simulation). This issue is a 'repeater' from 2006 where simulation time was 7.2 min.	Improvements of the LightCalc algorithm.
Simulation models sometimes corrupted by invalid input.	Implementation of more error messages in the tool.
Capability of simulating windows in more than one facade.	None (due to other priorities within the limited time of the project).
Excessive time used to establish a good starting point for the parameter variations. A 'repeater' from 2006 where the action was to provide various parameter variations as inspiration. This had little or no effect.	Instead of premade parameter variations, the students are asked to use a predefined iDbuild simulation model which fulfils the basic requirement as their starting point for the parameter variations.
Difficulties in interpretation of output, especially the air change graph.	Implementation of the 'foot-print' methodology from EN 15251 [5] annex I.2.
The possibility to make a more detailed evaluation of energy performance.	Implementation of a graph illustrating the individual energy consumptions (heating, cooling, fans, lighting, etc.).

Difficulties in setting up appropriate control of building services.	Predictive control project initiated mid-2008 (see section 6.1 and paper II in appendix A).
Misinterpretation of the purpose of the assignment. Some groups made parameter variations without using them to generate proposals for room designs.	Emphasis on better communication of the purpose of the assignment and tool in lectures (i.e. to use the parameter variations as design advice when generating design support in the form of 2x3 proposals for room designs).
A number of bugs in the tool identified by the students.	Correction of bugs (see the revision history of the tool in the iDbuild User Guide chapter 8, version 2.4.2 to version 3.0).
A number of relevant suggestions from students to improve the user interface and illustration of output.	Implementing relevant suggestions.
Facilitation of design decisions based on parameter variations.	All design decisions based on parameter variations need to be put into a new model to be evaluated as a whole. This process can be integrated in the user interface to reduce data processing time.

4.1.6 Iteration 3

The third iteration took place in the fall of 2008 where a total of 16 groups (33 students) were attending the master course.

4.1.6.1 Developmental stage of the tool and other initiatives to improve operability

The third major version of the tool was following the direction laid down in the 2007 version. However, the new version contained a substantial amount of new features and improvements. The main initiatives were the design of a new user interface for window definition and for system settings with the aim to improve the operability of the tool. Furthermore, initiatives to improve the interpretation of the output and a feature for facilitation of design decisions based on parameter variations were implemented, see Figure 22 and Figure 23. For further details on changes to the program, see the revision history of the tool in the iDbuild User Guide¹⁶ chapter 8 (version 2.4.2 to version 3.0).

¹⁶ The user guide is provided together with the tool at <http://www.idbuild.dk>

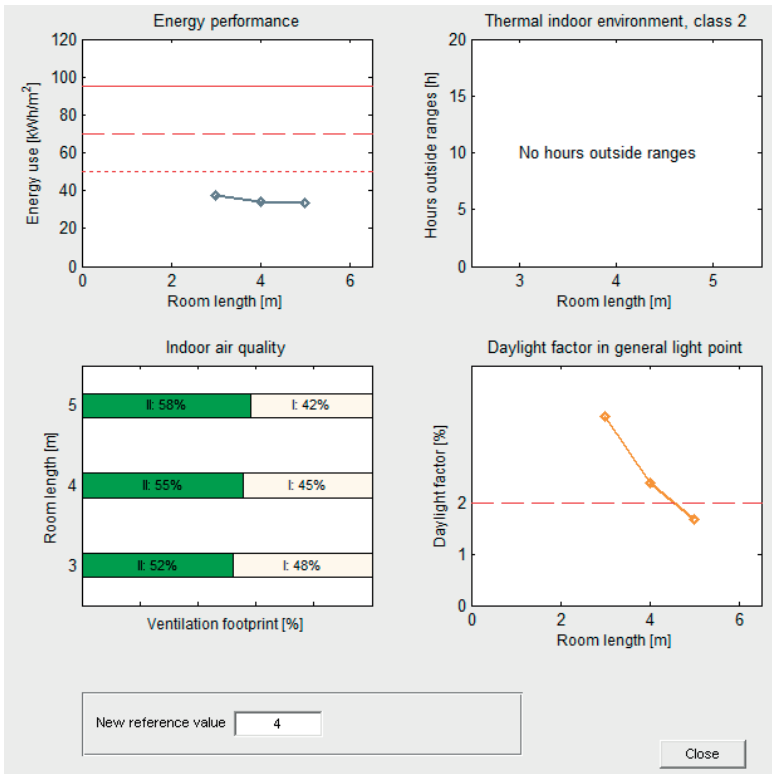

Figure 22. Overview of output from parameter variation (continuous measure), iDbuild version 3.0 (2008). The indoor air quality graph is now based on the 'foot-print' methodology from EN 15251. Furthermore a feature for facilitating informed design decisions is implemented in the bottom of the output (see paper I in appendix A for details).

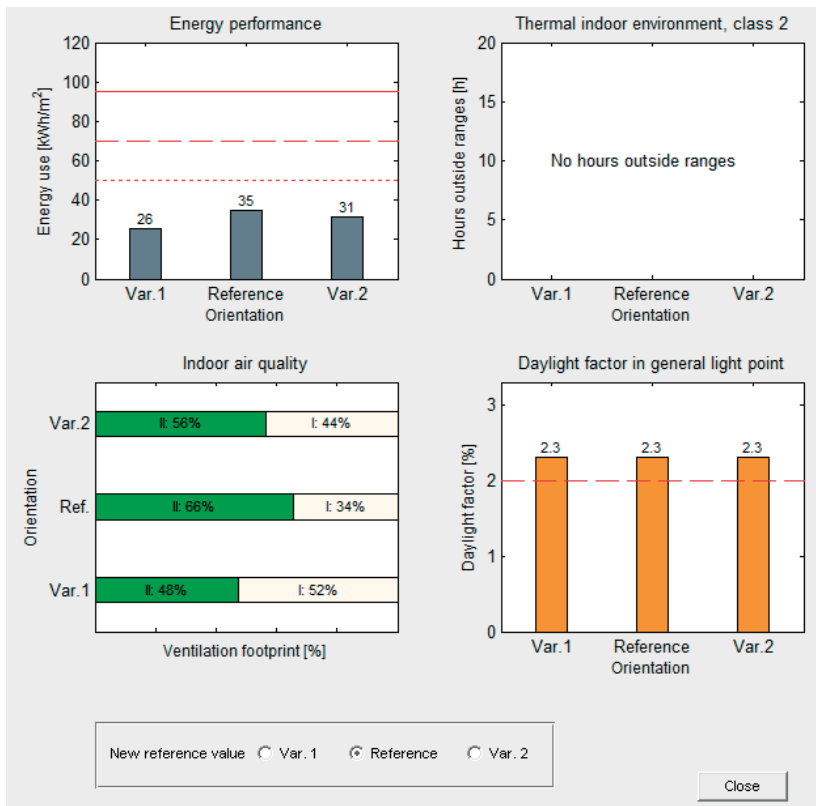

Figure 23. Overview of output from parameter variation (discrete measure), iDbuild version 3.0 (2008). The indoor air quality graph is now based on the 'foot-print' methodology from EN 15251. Furthermore a feature for facilitating informed design decisions is implemented in the bottom of the output (see paper I in appendix A for details).

Besides the tool-related changes, the students were asked to use a predefined iDbuild simulation model of an office as starting point for the parameter variations. This initiative substitutes the handing out of premade parameter variations for inspiration to establish a good starting point in 2007. The students were not given any predefined iDbuild simulation model for the seminar room. The idea was that the students after working with the office were experienced enough to make their own good starting point. This also makes it easier to assess whether the handing out of a good starting point has any effect on operability, e.g. by comparing the rate of success incl. partial success for office (predefined simulation model handed out) and seminar room (no predefined simulation model handed out).

Furthermore, more time was used in the lectures of the master course to put emphasis on the purpose of the assignment and tool, i.e. to use the tool for making parameter variations which then is used to generate design support to the overall building design process in the form of 2x3 proposals for room designs.

4.1.6.2 Data from student reports

The structure of the presentation of the data collected from the student reports is given according to the four points listed in section 4.1.2.

Issue 1: The number of rooms fulfilling the basic requirements

The number of groups who managed to design three, two, one and zero room designs for the two different functions (office and seminar room) is shown in Figure 24. The raw data and individual comments to each student report can be found in appendix C. Table 8 provides the students' rate of success.

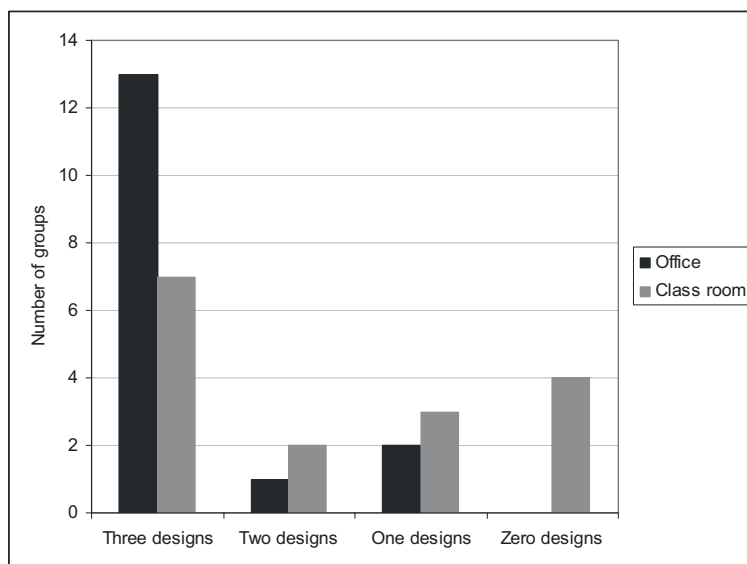

Figure 24. The number of groups who managed to design three, two, one and zero room designs for the two different functions (office and seminar room) in 2008.

Table 8. Rate of success, fall 2008

Function	Rate of success	
	Absolute	Percentage
Total rate of success	6 groups out of 16	38 %
Rate of success, office	13 groups out of 16	81 %
Partial rate of success, office	4 rooms out of 48*	9 %
Rate of success, seminar room	7 groups out of 16	44 %
Partial rate of success, seminar room	7 rooms out of 48**	14 %

*4 rooms out of 48 possible (if all groups had designed three rooms: 3x 16 groups = 48)

**7 rooms out of 48 possible (if all groups had designed three rooms: 3x 16 groups = 48)

Issue 2: Student statements about pros and cons

The following statements were given by the students in their reports.

Student appreciations:

- iDbuild gives us a chance to make impact on the early decisions in the building design process.
- The tool is very simple to use.
- The wide range of measures that the tool can handle (overhangs, shading devices, etc.).
- The graphical output is very clear for a quick evaluation of the indoor environment and energy performance.
- iDbuild is a fast way to get an idea about the performance of the different rooms and how different parameters can influence this performance.

Student criticism:

- Long waiting time due to long simulation time (an increased number of students raise this issue compared to 2006 and 2007).
- Tool limitation: Only one window in one façade, and only rectangular rooms.
- Tool limitation: The glazing database only has a few types of complex façade systems and it is difficult to generate data for 'innovative' façade solutions fit for iDbuild.
- Using the predefined iDbuild simulation model as starting point for the parameter variations is not a good idea because we do not learn how to build up a model 'from scratch'. This deprives us of the possibility to gain a more in-depth knowledge of the capabilities of the tool.
- Difficult to design a seminar room fulfilling the requirements.
- Some program bugs interrupted the process.

Issue 3: Academic prerequisites and time spent on the assignment

Data collected from the course evaluation is given in the following.

Academic prerequisites

Answer percentage: 48.5 %
(16 out of 33 students)

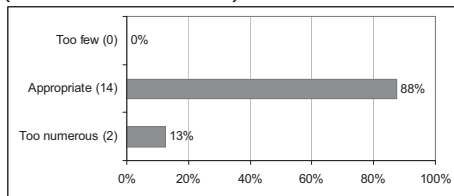

A total of 100 % of the students answering felt they had sufficient academic prerequisites.

The amount of time spent on the assignment (i.e. more than nine hours per week)

Answer percentage: 51.5 %
(17 out of 33 students)

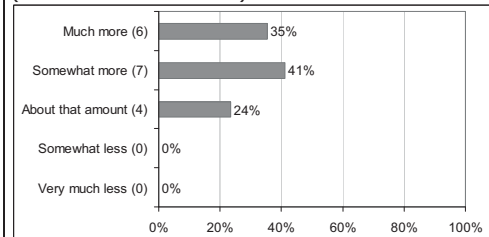

A total of 76 % of the students answering felt they had used more time than expected.

4.1.6.3 Data from observations

The following was recorded during the observation of the students working on the task:

- Increased frustrations (compared to the previous years) regarding simulation time which was considered too long (8.0 min per simulation¹⁷).
- Only a few program bugs found by the students.
- Various ideas for better user interfaces recorded.
- Generating design proposals for the office was relatively easy for the students because they had a predefined starting point.
- Problems establishing even one seminar room design fulfilling the basic requirements.
- The newly implemented feature for facilitation of design decisions based on parameter variations had too many bugs to be useful to the students.

Additional observations from assessment of student reports:

- A rise in positive comments in relation to the tool, but it was not always clear that the students understood the intended role (and thereby their own role) of the tool in the overall building design process.

4.1.6.4 Test of *SH 1* and suggestions for improvement

In this section the data from the previous sections is used for testing *SH 1: It is possible to establish an operational tool for parametric analyses of the energy performance and indoor environment which can be used for generating input to the building design process.*

The rate of success is decreasing from 47 % in 2007 to 38 %. The reason is mainly ascribed 1) the fact that many students felt that they used excessive time on the assignment (an increase from 69 % in 2007 to 76 %) due to long simulation time and therefore had less time for generating design proposals, and 2) that the students had problems establishing even one seminar room design fulfilling the requirements. Despite the decrease, the rate of success still suggests that it is possible to establish a tool for generating the sought output (proposals for room designs). But the critical issue in relation to *SH 1* is still whether the tool can be designated 'operational'.

In relation to operability, an interesting development is that the rate of success incl. partial success for generating proposals for office designs increased from 54 % and 64 % in 2006 and 2007, respectively, to 90 %. In the same period the rate of success incl. partial success for generating proposals for seminar room designs is relatively stable (54 %, 64 % and 58 % in 2006, 2007 and 2009, respectively). The sudden increase in rate of success incl. partial success for generating proposals for office designs is ascribed the fact that the students were using a predefined iDbuild simulation model of the office – a model fulfilling the basic requirements – as starting point for the parameter variations. This eliminated the, for the novice students, time

¹⁷ Simulation time measured for the 18 m² office described in Paper I using a laptop with a Pentium M processor running at 1.86 GHz and 2 GB of RAM.

consuming task of establishing a good starting point for parameter variations, i.e. a room design fulfilling the requirements. In comparison, the students were not provided with a predefined model for the seminar room. This indicates that the operability of the tool increases when the students are provided with a predefined iDbuild simulation model of the room. Another interesting development is that none of the student groups misinterpreted the purpose of the assignment. This indicates that communication of the purpose of the tool and the assignment has improved.

There are, however, still data that argue against a full corroboration of *SH 1* in terms of operability. The major issue is that a too large fraction of the students reports excessive time used on the assignment which mainly is ascribed the notion that simulations take too long time. The fact that simulation time increased from 6.8 to 8.0 minutes (due to improvements of the LightCalc algorithm for better precision of daylight calculations) is regarded as the main reason for an increase in the notion of excessive time used on solving the assignment.

The rate of students who felt that their academic prerequisites were sufficient to solve the assignment is 100 %. This issue was therefore not an immediate hindrance in terms of solving the assignment. This was in general confirmed by observing the students working on the assignment.

The overall conclusion is that the data, when accepting certain premises, corroborates SH I. The premises are 1) that the 90 % rate of success incl. partial success for the generation of design proposals for offices (a consequence of the use of a predefined iDbuild simulation model as starting point for the parameter variations) is accepted as an indicator for a high degree of operability, and 2) that the notion of a long simulation time is neglected.

An issue which may need to be addressed in the future is the occurrence of a conflict between what the students expect to learn in the course and the aspiration for operability of the tool. A number of groups state that using the predefined iDbuild simulation model as starting point for the parameter variations is not a good idea because it deprives them from the possibility to gain a more in-depth knowledge of the capabilities of the tool. The groups would rather learn to build up a model from scratch so they may gain a more generic knowledge about the tool which can be used in various types of future projects. The dilemma is that providing starting points seems to increase the operability of the tool in terms of generating the sought output (the proposals for room designs).

Processing the data from the student reports and the data from observations give rise to the actions for improvements in Figure 9 before the tool is used again in the fall 2009.

Table 9. Issues experienced when testing the tool, and suggested actions for improvements (fall 2008).

Issues	Actions for improvement
The feature for facilitation of design decisions based on parameter variations has too many bugs to be useful.	Correction of bugs.
Conflict between what the students expect to learn in the course and the aspiration for operability of the tool.	Introducing on how to build up a model in the lectures, and making it clear that building up models from scratch when solving the assignment is not recommended.
Simulation time considered too long (8.0 min per simulation). This issue is a 'repeater' from 2006 and 2007.	Improvements of the LightCalc algorithm.
Capability of simulating windows in more than one facade.	None (due to other priorities within the limited time of the project).
The possibility for evaluating more complex façade systems.	Project regarding the potential for using BTDF in iDbuild initiated (see section 6.3 and Report I).
Excessive time used to establish a good starting point for the parameter variations when designing seminar rooms.	As for the office, the students are asked to use a predefined iDbuild simulation model which fulfils the basic requirement as their starting point for the parameter variations.
Difficulties in setting up appropriate control of building services.	Predictive control project continued (see section 6.1 and paper II in appendix A).
Bugs in the tool identified by the students.	Correction of bugs (see the revision history of the tool in the iDbuild User Guide chapter 8, version 3.0 to version 3.2.3).
Various ideas for better user interfaces.	Implemented (see the revision history of the tool in the iDbuild User Guide chapter 8, version 3.0 to version 3.2.3).

As stated in section 4.1.6.3, it was not always clear that the students understood the intended role (and thereby their own role) of the tool in the overall building design process. Therefore the 2009 students were asked to write maximum one page where they explain the overall aim and usability of the tool and the generated design support (room designs) and how it may be a help to the design group throughout the initial design phase. The explanation should be made in a way that a third party, e.g. an architect, would be able to understand it. Besides demonstrating an understanding of the purpose of the tool and its output, this also trains the students to make a third party understand. This is important in relation to whether the tool and its output are ever going to be considered useful in a real design project.

4.1.7 Iteration 4

The fourth iteration took place in the fall of 2009 where a total of 22 groups (49 students) were attending the master course.

4.1.7.1 Developmental stage of the tool and other initiatives to improve operability

The fourth major version of the tool is a more or less a bug-corrected 2008 version. Details may be found in Paper I in appendix A which is based on this version. Furthermore, a feature for

including artificial lighting in LightCalc was implemented with the aim to investigate methods for optimal control of LED lighting systems [72]. The long-term perspective is to couple this feature to iDbuild for annual performance evaluations. For further detail on changes to the program, see the revision history of the tool in the iDbuild User Guide, chapter 8 (version 3.0 to version 3.2.3).

Besides the tool-related changes, the students were asked to use a predefined iDbuild simulation model of an office and a seminar room as starting point for their parameter variations. The difference from 2008 is that the students now have a starting point for both the office and the seminar room. The idea is to assess the effect of handing out a predefined iDbuild simulation model fulfilling the basic requirements by comparing the rate of success incl. partial success for generating proposals for seminar rooms with the rate from 2008.

4.1.7.2 Data from student reports

The structure of the presentation of the data collected from the student reports is given according to the four points listed in section 4.1.2.

Issue 1: The number of rooms fulfilling the basic requirements

The number of groups who managed to design three, two, one and zero room designs for the two different functions (office and seminar room) is shown in Figure 25. The raw data and individual comments to each student report can be found in appendix C. Table 10 provides the students' rate of success.

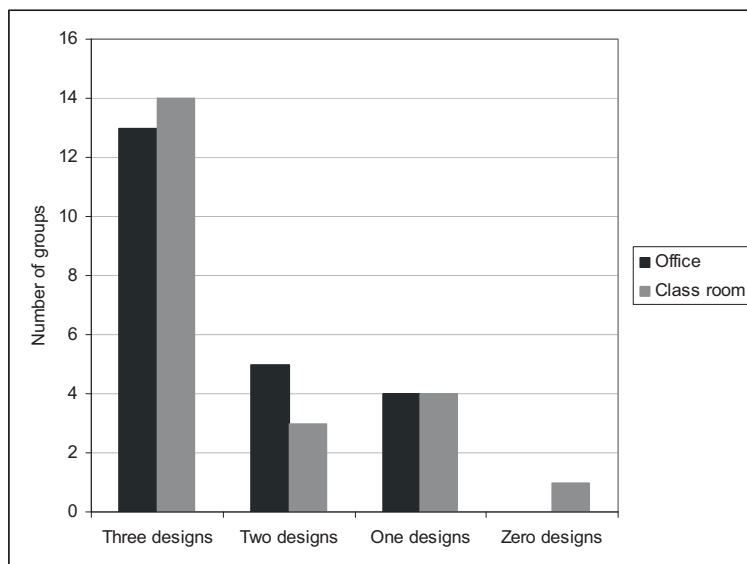

Figure 25. The number of groups who managed to design three, two, one and zero room designs for the two different functions (office and seminar room) in 2009.

Table 10. Rate of success, fall 2009

Function	Rate of success	
	Absolute	Percentage
Total rate of success	12 groups out of 22	55 %
Rate of success, office	13 groups out of 22	59 %
Partial rate of success, office	14 rooms out of 66*	21 %
Rate of success, seminar room	14 groups out of 22	64 %
Partial rate of success, seminar room	10 rooms out of 66**	15 %

*14 rooms out of 66 possible (if all groups had designed three rooms: 3x 22 groups = 66)

**10 rooms out of 66 possible (if all groups had designed three rooms: 3x 22 groups = 66)

Issue 2: Student statements about pros and cons

The following statements were given by the students in their reports.

Student appreciations:

- iDbuild is efficient and user-friendly.
- The connection between iDbuild and Google Sketchup was very useful.
- The program is a good tool to give a quick assessment of the indoor climate and energy use in a room, in the early state of the design process.
- The program is very fast to use because it only needs few inputs.

Student criticism:

- Program bugs interrupted the process.
- Tool limitation: Only one window in one façade, and only rectangular rooms (an increase in groups who raises this issue).
- Long waiting time due to long simulation time (Same magnitude of students raise this issue compared to 2008).
- Economical and financial issues were not taken into account. When the variations were done it could be interesting to have the economical consequence of potential design decisions.

Furthermore, there were many concrete suggestions for features to be implemented in the tool, e.g. representation of floor heating, a better module for natural ventilation, phase changing materials, and a better representation of mullions and transoms.

Issue 3: Academic prerequisites and time spent on the assignment

Data collected from the course evaluation is given in the following.

Academic prerequisites

Answer percentage: 59.3 %
(30 out of 49 students)

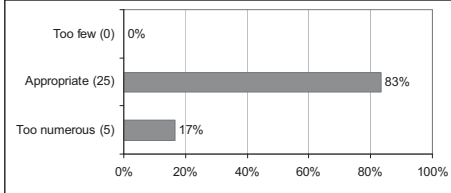

A total of 100 % of the students answering felt they had sufficient academic prerequisites.

The amount of time spent on the assignment (i.e. more than nine hours per week)

Answer percentage: 59.3 %
(30 out of 49 students)

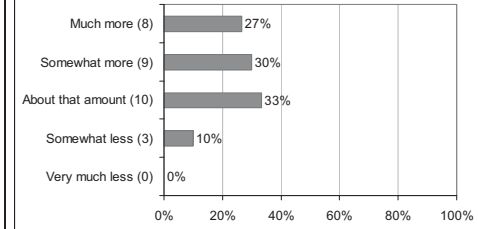

A total of 57 % of the students answering felt they had used more time than expected.

4.1.7.3 Data from observations

The following was recorded during the observation of the students working on the task:

- Some frustrations regarding simulation time (8.0 min per simulation¹⁸).
- The handing out of starting points reduces the number of design iterations (simulations).
- Some program bugs found by the students.
- Generating design proposals for the office and the seminar room was relatively easy for the students (compared to the previous years) mainly because they had a predefined starting point for parameter variations.
- Some groups insisted on making their own starting points for a more in-depth learning of the tool.
- The feature for facilitation of design decisions based on parameter variations was used but it was not as widespread as hoped.
- Only a few used predictive control instead of more traditional control of building services.

Additional observations from assessment of student reports:

- Many positive comments in relation to the tool.
- Many detailed explanations of potential new features to the tool.
- Compared to the other years, the students had more time to generate design proposals because they did not have to spend time on generating a good starting point.
- Making the students write a page explaining the overall aim and usability of the tool and the generated design support (room designs) and how it may be a help to the design group throughout the initial design phase was a partial success. The majority of groups demonstrated good or acceptable understanding, some chose to discuss integrated design

¹⁸ Simulation time measured for the 18 m² office described in Paper I using a laptop with a Pentium M processor running at 1.86 GHz and 2 GB of RAM.

process in a broader perspective without involving the overall aim and usability tool and its output, and some misunderstood the purpose of the assignment.

4.1.7.4 Test of *SH I* and suggestions for improvement

In this section the data from the previous sections is used for testing *SH I*: *It is possible to establish an operational tool for parametric analyses of the energy performance and indoor environment which can be used for generating input to the building design process.*

The rate of success is increasing from 38 % in 2008 to 55 % which also is the highest rate of success from 2006 to 2009. Furthermore, the rates of success incl. partial success are relatively high compared to the previous years. Especially the recurrence of a high rate of success incl. partial success for the generation of proposals for offices (80 %) and for the seminar rooms (79 %) compared to the previous years are interesting. The relatively high increase for seminar rooms is ascribed to the fact that the students were using a predefined iDbuild simulation model – a model fulfilling the basic requirements – as starting point for the parameter variations. This is supported by the fact that the use of a predefined iDbuild simulation model led to a high rate of success in 2008 for offices (90 %) – a rate which is maintained on a relatively high level in 2009 (80 %).

Another interesting development, especially in light of increasing rates of success, is that the number of students expressing an excessive time used on the assignment is decreasing to the lowest level in all four years (55 %). This is again ascribed the fact that the students were using predefined iDbuild simulation models as a starting point for the parameter variations. Observations of the students working on the task show that the students, compared to the other years, had more time to generate actual design proposals. This was mainly because they avoided the often extensive amount of simulations to come up with a good starting point for the parameter variations. The students now only had to spend simulation time on parameter variations (the foundation for informed design decisions) and simulations of the solutions based on a range of informed design decisions thus leaving more time for generating design proposals. Decreased simulation time is not a factor in this relation since simulation time has not decreased compared to 2008. However, a large fraction of the students reporting excessive time used on the assignment blames simulation time.

An unfortunate development is that four student groups misinterpreted the purpose of the assignment after a year (2008) where no groups misinterpreted the purpose. Leaving these groups out, the rate of success is 67 % and the rates of success incl. partial success is 91 % and 89 % for the office and the seminar room, respectively. This, once again, stresses the importance of a clear and unambiguous communication of the purpose of the tool and the assignment.

The rate of students who felt that their academic prerequisites were sufficient to solve the assignment is 100 %. This issue was therefore not an immediate hindrance in terms of solving the assignment. This was in general confirmed by observing the students working on the assignment.

Overall the different rates of success strongly corroborate that it is possible to establish a tool for generating the sought output (proposals for room designs). Furthermore, the high rates of success incl. partial success is a clear improvement in terms of the more critical issue in relation to *SH I*, namely whether the tool can be designated 'operational'. *The conclusion is therefore that the data shows a rather wide corroboration of SH I.*

Processing the data from the student reports and the data from observations give rise to the actions for future improvements in Figure 11.

Table 11. Issues experienced when testing the tool, and suggested actions for improvements (fall 2009).

Issues	Actions for improvement
The use of the feature for facilitation of design decisions based on parameter variations was not widespread.	Emphasis on better communication of the purpose and possibilities of this feature.
Simulation time considered too long (8.0 min per simulation). This issue is a 'repeater' from 2006, 2007 and 2008.	Improvements of the LightCalc algorithm.
Capability of simulating windows in more than one façade.	To be included in a future release.
The use of predictive control was not widespread.	Emphasis on better communication of the purpose and possibilities of the predictive control in lectures.
Bugs in the tool identified by the students.	Correction of bugs (see the revision history of the tool in the iDbuild User Guide chapter 8, version 3.2.3 to version 3.2.4).
Various ideas for new features to the tool.	Considerations initiated to include these in future releases.

4.1.8 Current developmental stage of the tool

The developmental stage of the tool in March 2011 (the same month as the submission of this thesis) is more or less as the 2009 version in terms of the user interface and output. Only a small number of bugs are reported by users. There are, however, a number of new features which may improve the operability of the tool:

- Simulation time has decreased by more than 50 % for LightCalc and iDbuild due to mex compilations of computationally heavy LightCalc algorithms. Simulation time is now 3.8 min per simulation¹⁹.
- The setup of predictive control is facilitated by guiding text. Setting up predictive control will, all other things being equal, reduce time for setting up systems compared to setting up more traditional control of building services (see paper II in appendix A and section 6.1 for details).

¹⁹ Simulation time measured for the 18 m² office described in Paper I using a laptop with a Pentium M processor running at 1.86 GHz and 2 GB of RAM.

- A method for component-based economical optimisation for use in design of new low-energy buildings has been developed (see paper III in appendix A and section 6.2 for details). The method is currently not an integrated part of iDbuild but the future perspective is 1) to automate the process of generating a room model which acts as a good starting point for the parameter variations, and 2) to use the method to add an economical dimension to the informed design decisions.

It is stressed that none of the above features have been assessed in terms of whether they have an influence on operability.

4.2 Conclusion

This section provides an overall analysis of the data gathered in the master course, and the result from the tests of *SH I*. Finally, an overall conclusion is derived.

Figure 26 provides an overview of data gathered in the master course. The figure illustrates the tendency that the rates of success are increasing while the rate of students reporting excessive time used is decreasing. This is considered a rather positive tendency illustrating that the user-driven development has resulted in a tool which seems to enable energy engineers to 'get more done in less time'.

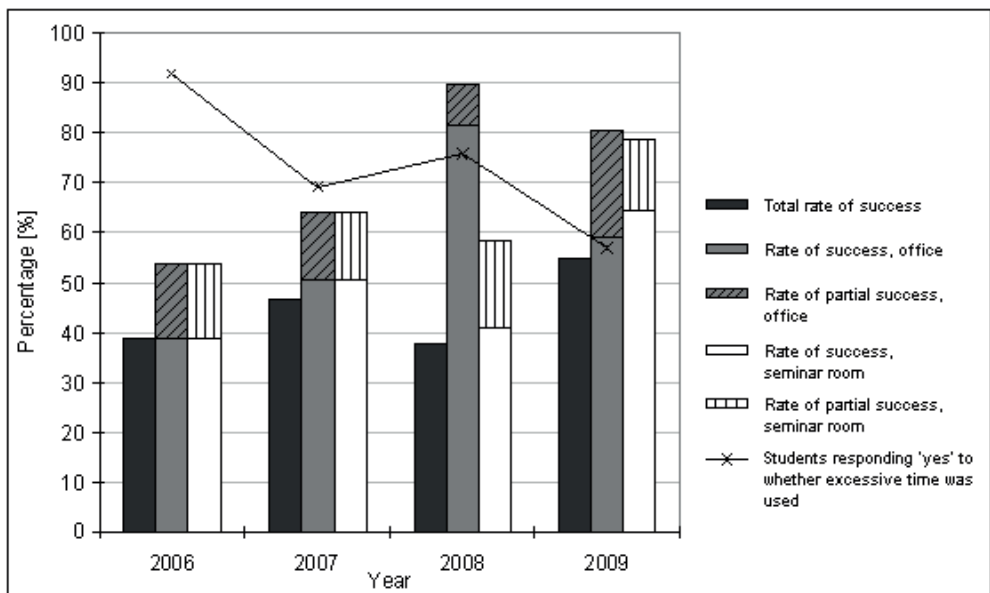

Figure 26. Overview of data gathered in the master course to test sub hypothesis I.

In all four years of testing, there was a general notion among the students that the simulation time was too long. However, the number of students answering 'yes' to whether excessive time

was used decreased over time, even though simulation time within the same period actually increased. This indicates that simulation time is not the only factor in relation to minimising time consumption (and thereby improving the operability of the tool). The decreasing number of students answering 'yes' to whether excessive time was used is primarily ascribed the handing out of predefined iDbuild simulation model – a model fulfilling the basic requirements – as starting point for the parameter variations. As a consequence, the students had more time to spend on generating actual design proposals because they avoided the often extensive amount of simulations to come up with a good starting point for the parameter variations. This indicates that the *amount* of simulations needed for generating design proposals may be (at least) just as important to the operability of the tool as the simulation time for a single simulation.

Based on the above data, it is concluded that it is possible to establish a tool for generating proposals for room designs, and that the tool can be designated 'operational'. The latter, however, presupposes that predefined simulation models are used as starting point for the parameter variations (the foundation for informed design decisions) to minimise the time used for generating a range of room design proposals. Bearing this in mind, *the overall conclusion is that the tool, with minor reservations, fulfils the criteria for a corroboration of SH I.*

It is noted that there still is room for improvements in terms of operability. There seems to be a great unrealised potential for better operability in the reduction of simulation time. Another unrealised potential in relation to improve operability seems to be the establishment of features for facilitating the set up of simulation models. Two of such features has been suggested in this thesis (see paper II and III) but they have not been tested in relation to whether they improve operability. Finally, it is remarked that the adoption of the SER-model (see section 1.2.2) as an overall philosophy was quite helpful in the effort to develop an operational tool. It is difficult to imagine that the conclusion above could have been formulated without involving a substantial amount of users of the tool directly in the process of development.

5 The usability of simulation-based design support

This chapter documents the research work related to the tests of sub hypothesis II: *The output from the parametric analyses is useful in the overall design process.*

The research methodology to test *SH II* is described in detail in section 1.2.3 and is briefly summarised here. The fact that the research project was partially anchored in a professional consultancy enabled the author to be a part of the design group of three real building design projects. In all projects, output from the tool was presented to the design group at an early stage of the process as an input to the integrated building design process. The data basis for a test of *SH II* was then generated by observing how the design group were using this input and through interviews with the participants of the design groups.

Furthermore, the tool was used in two master projects where the aim was to design a low-energy office building with high indoor environment quality. The experiences from these two projects could provide some new dimensions in terms of *SH II* (i.e. the usability of the design support).

5.1 Real building design projects

The author's ¼ time position in a professional building consultancy enabled the test of the tool in professional settings. The author was involved in three real design projects. In each project the author had the role as energy engineer in interdisciplinary design groups which in all three cases also encompassed architects, construction engineers and contractors. In all three projects the tool was used to generate design support for design decisions in the conceptual design stage.

In this section a resume of the design processes of the three different buildings are described based on the author's observations. Focus is on how the output from the tool was used in the design processes. Furthermore, the essence of interviews with participants of the design groups providing their honest assessment on the usability of the design support is given. The purpose is to gather data for a test of *SH II* (see section 1.2.3 for further details).

5.1.1 Office building, COM III

The first project was a 4.300 m² office building in the city of Kolding called COM III which was completed in 2009. This section provides a description of the design process based on the author's observations.

The performance requirement in terms of energy consumption was a maximum 70 kWh/m² per year, and class I according to EN 15251 in terms of thermal and indoor air quality. A time frame of two months for the establishment of a full project proposal made it a time-wise compressed design process. Initially, there was a reluctant attitude towards the idea of multidisciplinary collaboration in the early stages of design. The main reason was a concern that the design process would become very time consuming. The building design process therefore started up in a more traditional way, i.e. to let the architects come up with a building form fit for the context and facilitation of the desired functionality and flexibility. Consequently, the design support generated by the tool was constrained to encompass the façade design only. So instead of presenting a range of possible room designs, the design team was presented with solution spaces for the façade design. Table 12 is an example of a solution space for three different glazing types for a south-facing office section. All solutions are fulfilling the design brief regarding thermal indoor environment, air quality and daylight factor. The solution space thus represents possible solutions for fulfilling the basic design requirements.

Table 12. Example of solution space for three different glazing types for a south-facing office section generated with the method and tool.

Glazing type	Glazing with low emissivity coating			Glazing with solar control coating			Glazing with low emissivity coating, external blinds		
	Fully glazed	Window height* [m]		Fully glazed	Window height* [m]		Fully glazed	Window height* [m]	
		Min.	Max.		Min.	Max.		Min.	Max.
Minimum requirements	÷	1.15	2.10	OK	1.25	2.10	OK	1.15	2.10
Low energy class 2	÷	1.15	1.55	÷	1.25	2.10	OK	1.15	2.10
Low energy class 1	÷	÷	÷	÷	÷	÷	÷	1.15	2.00

*0.8 m offset from floor. The window forms a horizontal band across the façade, see Figure 27.

The solution space for energy and indoor environment was constrained by the overall demand for a building in low-energy class 2. Furthermore, there were economical and architectural reasons to avoid a solution with external shading devices, an architectural desire to maximise the window area, and an economical desire to minimise the window area. The compromise fulfilling all constraints was a 1.7 m high window band with solar control coated glazing. The final façade design is illustrated in Figure 27.



Figure 27. COM III in Kolding, Denmark.

5.1.1.1 Interview with the integrated design facilitator

This section provides the essence from an interview with the integrated design facilitator who had the role of facilitating the interdisciplinary building design process, Lars D. Christoffersen (engineer and PhD) from the consulting company ALECTIA A/S.

Question: *Please outline the general framework conditions of the building design process.*

Answer: The design process was in many ways different from a traditional building design process because it was decided to adopt a design process based on interdisciplinary collaboration from day 1. In other words, a process which I believe could be called an integrated design process. This kind of building design process was new to all of the actors involved (author's note: developer, tenant, architects, engineers and contractor) who all were used to a more artistic design process where the architect establishes an overall building design which respects some physical, aesthetic and functional boundary conditions – without considering other issues such as energy performance, quality of indoor environment and HVAC routing very much. The background for choosing an integrated design process instead of the more traditional approach was the relatively strict performance requirements. The developer and the future tenants required an indoor environment quality in class I

according to EN 15215 (thermal and air quality) and a daylight factor of 2 % on all working stations. Furthermore, the energy requirement was low energy class 2 (70 kWh/m² year) which was 25 % lower than the minimum requirement in 2006 (95 kWh/m² year). My notion was that only an integrated design process could ensure that these (at that time) strict requirements was fulfilled within the project economy. The developer (the owner of the project) agreed – and the other actors were kind of forced to deal with this decision.

Question: *How did you go about the integrated design process?*

Answer: One of the first tasks in integrated design is to align expectations in terms of the performance requirements. In this relation, it was a difficult to make all actors understand that the energy and indoor environment requirement were indisputable requirements which, all things being equal, would prompt certain boundary conditions to the architectural solution space. The architects were unsure of what these demands meant in relation to their degree of design freedom, and the contractor was worried that such a building would not be buildable within the budget.

Secondly, it was difficult to explain the workflow of the integrated design process to all of the involved actors – or rather get them to *understand* the workflow. Basically I advocated for a process where analytical input from especially the energy engineer was used actively as design support when establishing the overall building design. Unfortunately, the architects and the contractor never really understood the rationale of this process until it all was over. I guess it was a learning process for them. But everybody was more than happy with the end result.

Question: *Can you give a short description of the design input provided by the energy engineer in the building design phase?*

Answer: Let me start by outlining the workflow as it turned out in this project because it was not entirely the workflow that I was hoping for. As I said earlier, not all actors understood the rationale and purpose of the integrated design process and for that reason they never really accepted the process. So to get started (eventually) it was decided that the first move was to allow the architect to come up with a number of overall building layouts to be presented on the first common design workshop. At this common workshop the other actors should comment on the different building layouts, i.e. state pros and cons from their point of view. The goal of this workshop was that by the end of the day an overall building geometry was established.

The second workshop was about the design of the façade. Here the energy engineer presented a solution space for the façade which respected the energy and indoor environment requirements (author's note: see Table 12 for example). For the record, I believe that it would have been a more efficient process if the design team

more jointly were designing the overall building design using the space of solutions as design advice.

Question: *Did the actors find the input useful in relation to the overall building design process?*

I think it was very useful. I am not sure whether the architect thought so. But in the end it certainly had a crucial role in terms of fulfilling the performance requirements. It was the hope that the output from the second workshop was a main concept for the façade. However, despite the rather wide solution spaces provided by the energy engineer, and the fact that new ideas easily could have been assessed at the workshop, the architects found it difficult to relate the input to their creative process and in general to work parallel with the energy engineer. The developer and contractor related to the solution spaces based on their experience. As an example they were quick to rule out a design with an external blind which they stated was due to project economy and concerns about future maintenance costs.

The final outcome of the workshop was a solution space for the façade as in input to the architect and their further processing of the building design. This solutions space was however indisputable: the architects had to choose a solution within this space.

Question: *Do you have any suggestions for improvements in relation to the simulation-based design input?*

Answer: Explaining the overall framework of the design process in which the input may be useful is important. The experience from this project is that clear communication of the purpose and benefits of the integrated design process, i.e. to make the actors *understand* and *accept* it prior to any thing else, is crucial for whether the input is found useful. Make sure that the message is communicated on the actor's premises. To site Søren Kierkegaard: "If I want to succeed in guiding a person towards a certain goal, I have to meet this person where it is now, and start the journey from there". This presupposes good chemistry, respect for different professional competency, and the will to cooperate.

More concrete suggestion is to add more knowledge-based data in terms of economic consequence of design decisions. Economic decisions in the early design stage, maybe especially when it comes to life cycle costs, are often based on personal experience which may not be entirely up to date.

Question: *What is your overall, concluding assessment of having simulation-based design support as input to the overall building design process?*

Answer: The end result of this project is excellent. We reached goals which were better than our initial performance goals: the building is in low-energy class I while maintaining an indoor environment in class I. Furthermore, it is the first certified green office

building in Denmark (author's note: according to the EU GreenBuilding Programme, see www.eu-greenbuilding.org). All this was obtained to market price. It is my belief that the simulation-based design support we are discussing here had a crucial role in obtaining all this. I think that the input in the end was perceived as useful because of the strict performance demands – especially the energy demand. I expect that the type of input that we discuss here gets more and more important as the energy requirement for buildings are increasing. But the input is worth nothing without the acceptance of an overall design process in which the input can be used in a constructive manner.

5.1.1.2 Test of *SH II*

In this section the data from the previous sections is used for testing *SH II*: *The output from the parametric analyses is useful in the overall building design process.*

First of all, it was unfortunately not possible to test the intended form of the simulation-based design support (a range of possible room designs) in this project for various reasons. Instead the input was adjusted to fit the specific design process – a process which was not entirely ideal for utilising the full potential of simulation-based design support as it is presented in this thesis. But even so, the design facilitator directly states that the design input generated with the tool was very useful and had a crucial saying in the choice of glazing quality and size. Bearing this in mind, *the overall conclusion is that the experiences from the project COM III does to a wide extend corroborate SH II.* Both the author's observations and the interview with the design facilitator of the project show that simulation-based design support generated with the tool was used actively for making informed design decisions regarding the façade.

There were a number of barriers that obstructed the full use of the intended form of the simulation-based design support, namely a range of possible room designs:

1. As the design facilitator state, a majority of the actors in the design team was not entirely geared or ready to enter an interdisciplinary, integrated design process starting at the conceptual stage of design.
2. The design facilitator furthermore point out that a new and relatively strict energy performance requirement was an element of uncertainty to the design group: the architects were worried that this demand limited their architectural design freedom, and the contractor was worried that such a building would not be buildable within the budget. Consequently, a common and accepted goal in terms of energy performance was never established – even though it is considered a crucial prerequisite for an integrated design process [29] [30].

An essential learning from the COM III project that goes beyond the scope of this thesis is that the overall framework of the building design process and the attitude of the actors in the design

team are essential – not only for the acceptance of the interdisciplinary, integrated design process as the work form – but also for the acceptance of simulation-based design support as an input to the actual form giving of the building.

5.1.2 Multi-function building, Navitas

The second project is a 35.000 m² building in the city of Aarhus called Navitas to be completed in 2014. This section provides a description of the design process based on the author's observations.

The performance requirement in terms of energy consumption was a maximum 50 kWh/m² per year, and class II according to EN 15251 in terms of thermal and indoor air quality. The time frame of the conceptual design phase was four months. The building has various functions but mainly consists of offices, lecture rooms and workshops. As in the COM III project, the initial focus of the conceptual design stage was to generate a building form fit for the context and facilitation of the desired functionality and flexibility. But contrary to the form giving process of COM III, the design team of Navitas allowed the overall form to be influenced by design support generated with the tool.

Before starting the form giving process, the design team was presented with a range of analyses generated with the tool for each the main functions of the building. For each function two to three different room shapes were established, and a parameter variation of the orientation of different façade concepts was generated for each shape. Figure 28. and Figure 29 are examples of such variations. Figure 28. is an office for three persons and Figure 29 is a student group room for six persons. Both rooms have the same façade concept.

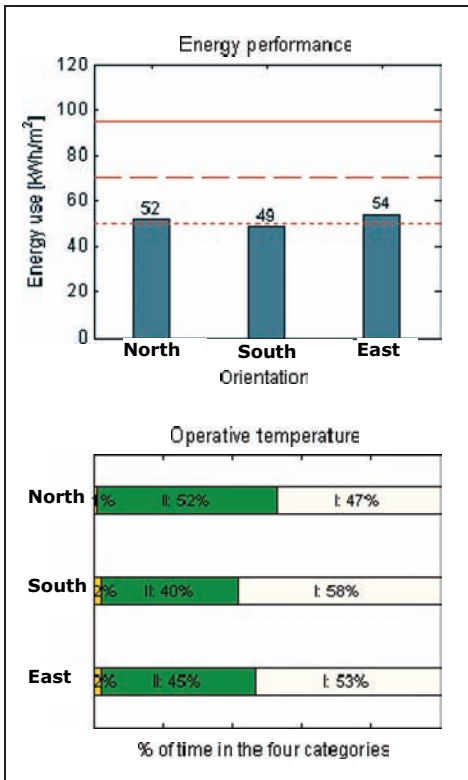

Figure 28. Variation of the orientation for an office for three persons.

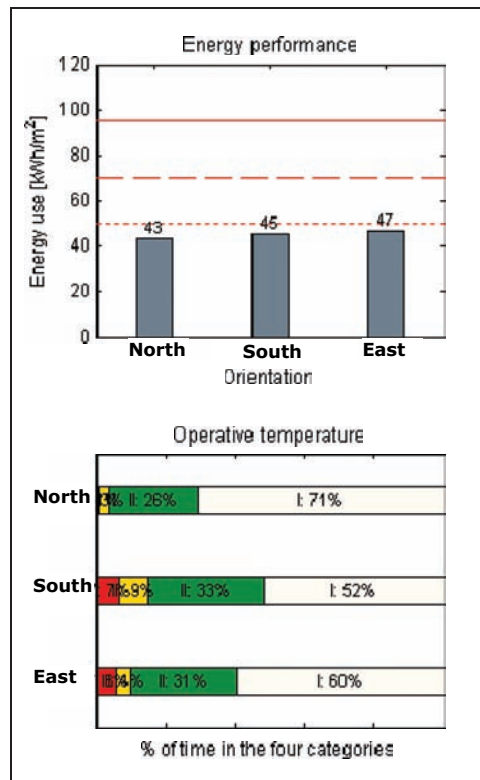

Figure 29. Variation of the orientation for a student group room for six persons.

For the office, Figure 28., the thermal indoor environment is acceptable for all orientations but south is preferred as it has the lowest energy consumption. For the group room, Figure 29, a north orientation is preferred since it is the only orientation which immediately fulfils the thermal indoor environment requirement. Furthermore, the north oriented group room has the lowest energy consumption.

It was observed that this type of design support had a direct influence on the form giving of the building. The design support was used actively as guidelines for design decisions regarding room geometries, architectural programming and façade design. Especially in the architectural programming where the relation between function and orientation was used as the argument for placing rooms with high internal loads, e.g. student group rooms, at northward facing, or shadowed, facades while rooms with minor internal loads were sought to be southward oriented. This is illustrated in a floor plan in Figure 30. The active use of the generated design support entailed that the compliance of the strict energy and indoor environment requirements was being integrated in the early design decisions rather than being a result of expensive, time-consuming sub-optimisations of an architectural arbitrary building form.

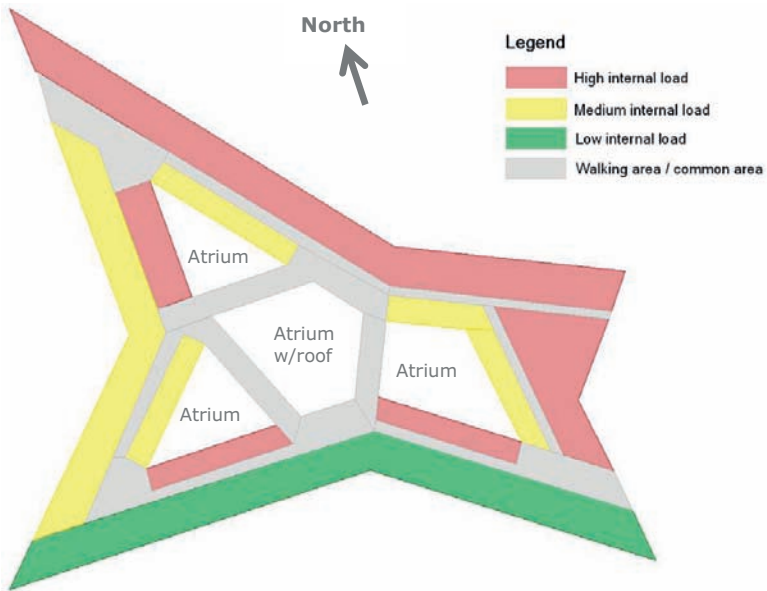

Figure 30. Floor plan for Navitas. Design support generated with the tool where used in the architectural programming.

Figure 31 are illustrations of the final building design. These illustrations serve as an example of a total building design which has been established with the use of the output from the tool.



Figure 31. Illustrations of the total building design for Navitas.

5.1.2.1 Interview with architect

This section provides the essence from an interview with the architect who had a superior responsibility for the architectural planning of the building in the competition phase, Michael Christensen from the architect company Christensen & Co.

Question: *Please outline the general framework conditions of the building design process.*

Answer: There was an ambition (author's note: in the design brief) that the process should result in an 'integrated energy design'. In my view this means that the functional and architectural idea, sustainability issues, low-energy requirements etc. should come together. For this project the challenge was – on an in many ways challenging and prestigious location – to design an architectural unique, multi-functional building while fulfilling a rather strict energy demand (author's note: low-energy class 1, i.e. an energy frame of 50 kWh/m² per year). The consensus in the design team was from day 1 that this energy demand should be reached by passive means (author's note: the Danish building requirement allows building designers to compensate overstepping of the energy frame by subtracting renewable energy produced on-site, e.g. solar thermal and /or power). This could be perceived as a self-inflicted tightening of an already challenging design brief but we were convinced that we could attain a higher level of architectural satisfaction if the fulfilment of the energy requirement was a directly consequence of our architectural dispositions.

Question: *Can you give a short description of the design input provided by the energy engineer in the early building design phase?*

Answer: At one of the common workshops we had at an early stage of the process, the energy engineer presented a range of simulation outputs and drawings illustrating the overall energy-related possibilities of the site, preferable placement of different functions in the architectural layout in terms of energy and indoor environment quality, and the consequence of different layouts, glass qualities and solar shadings of the façade.

Question: *Did you find the input useful in relation to the overall building design process?*

Answer: Yes, hell yes! To have this kind of information in the back head is a huge asset to the architects and their pending design synthesis. No doubt about that. It is, however, important that the input is tailored to concrete project. Every project is different.

What I also really appreciated in this project was the ability of the entire design team to enter a dynamic design process. An example is that we at a design meeting

were interested in the idea of putting a glass roof on the big atriums. While we considered the architectural impact, the contractor was calculating a price, and the energy engineer made an analysis in terms of energy performance (author's note: this analysis was not made with the tool but with the mandatory tool for compliance with the Danish building code [71]). Within few minutes we had a rational basis for a design decision. I believe that this kind of interdisciplinary real-time 'ping-pong' in the conceptual design phase is crucial in the development of genuinely sustainable buildings.

Question: *Do you see a potential risk of information overload?*

Answer: It depends on how big the issue of fulfilling a certain energy requirement is compared to other issues. If there is a bigger conceptual problem in the mind of the architect than the task of fulfilling a certain energy demand, numerous simulation-based inputs – as the one we discuss here – could be perceived as information overload because it is in relation to a secondary issue. But, again, the notion is different from project to project.

Question: *Another approach could be that the input is a single solution which is optimal in terms of energy performance and indoor environment. This solution is then adapted iteratively to also encompass other design issues. Do you see any perspectives in this?*

Answer: I understand the concept. I for one would often prefer to have a certain range of possible solutions over a single 'optimal solution'. An 'optimal solution' in terms of energy and indoor environment is in general not all that interesting to architects. I also think that there is a risk that the architect feels that the design process is 'locked' by such an input. So this approach might be counterproductive in terms of integrating such important issues.

Question: *Do you have any suggestions for improvements in relation to the simulation-based design input?*

Answer: Not really. I am not so worried about the current form of the input because the integrated energy design process requires that the energy engineer is around to explain and clarify the implications of the input. But of course, any initiatives that may improve the communication between the different actors in the conceptual design phase are always appreciated.

Question: *What is your overall assessment of having simulation-based design support as input to the overall building design process?*

Answer: To have this kind of information presented prior to the actual building design process is a huge asset to the architects and their pending design synthesis. In the following

conceptual design process, it is great to have someone with the ability to very quickly tell us the energy-related consequence of ideas that pops up. But it is often easy just to shoot an idea down. So instead of saying 'it is not possible', it is better for the process to have a 'yes, if you also do this and this...' as an answer – if possible. The energy engineer often has to be physically present where the process is happening. This makes demand on the personality and the professional profile. The person may be a specialist in a certain area but professional versatility and respect is essential.

5.1.1.2.2 Test of *SH II*

In this section the data from the previous sections is used for testing *SH II: The output from the parametric analyses is useful in the overall building design process.*

Both the author's observations and the interview with the architect responsible for the architectural planning shows that the design team to a great extend allowed room geometries, architectural programming and façade design to be influenced by design support generated with the tool. *The experiences from the Navitas project therefore corroborate SH II.*

The quite solid corroboration of *SH II* is very much ascribed to the fact that all actors of the design team from the very beginning were 1) fully aligned in terms of design goals, and 2) in agreement regarding the high value and usability of the simulation-based design support generated by the tool as input to the conceptual design stage.

5.1.3 Office building, Aarhus municipality

The project described here won 2nd place in a design competition for a 6.600 m² office building for the Aarhus municipality administration. This section provides a description of the design process based on the author's observations.

The performance requirement in terms of energy consumption was a maximum 25 kWh/m² per year (the expected minimum requirement in the Danish building regulations in 2020), and class II according to EN 15251 in terms of thermal and indoor air quality. The time frame of the conceptual design phase was three months. The building design process was an iterative process where proposals for room designs generated with iDbuild were used to inform the design of an overall building form fit for the context and facilitation of the desired functionality and flexibility. A special focus point in the design process was daylight accessibility. Aarhus municipality wanted a daylight factor of at least 3 % on all work places. The tool was therefore used to illustrate the effect of parameters which have significant impact on daylight performance in the different room designs. Figure 32 shows the distribution of daylight in a 1-person office room as a function of façade window height – one of the many daylight analyses performed to inform the building design process.

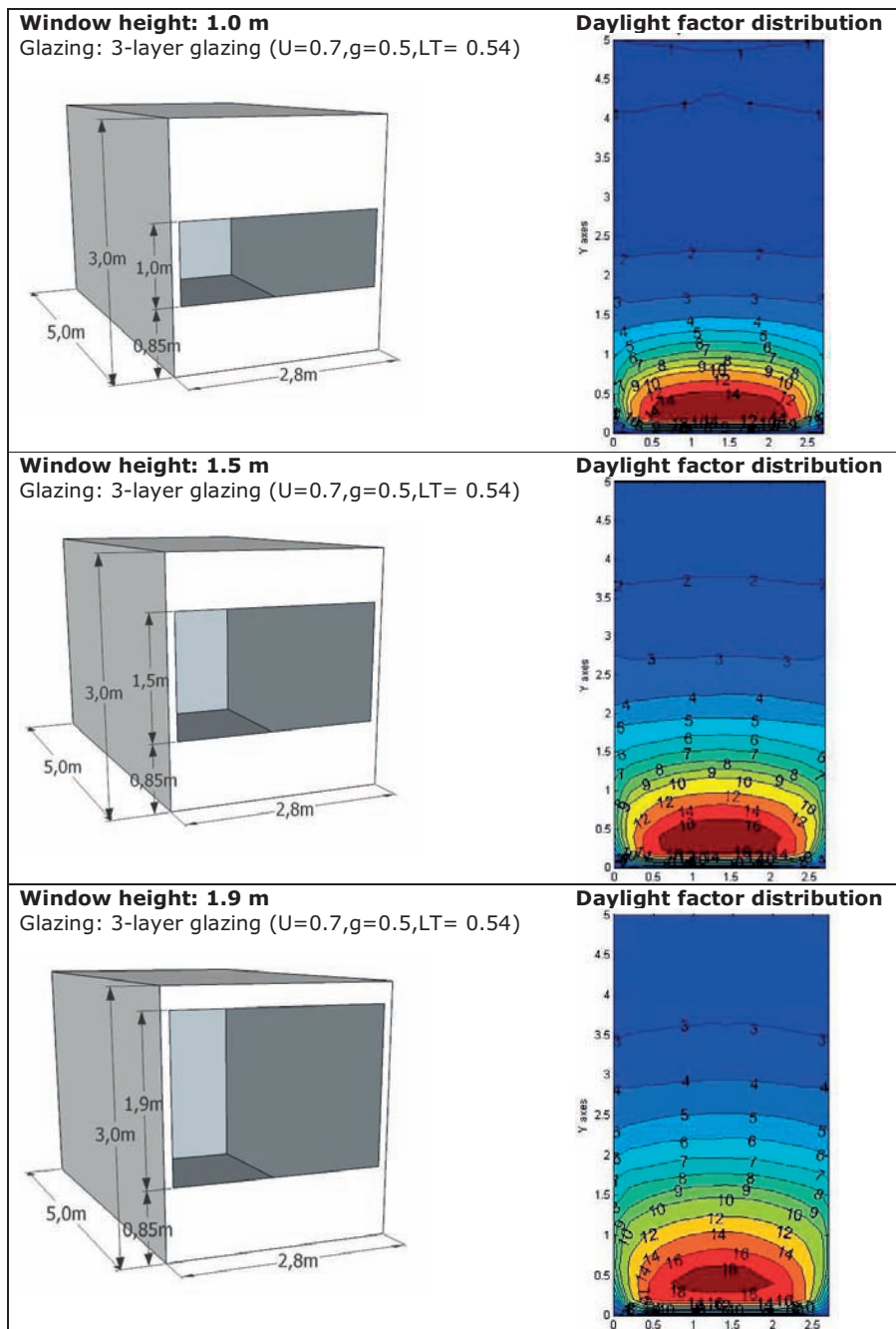

Figure 32. Three room designs with different daylight factor distributions due to different window heights.

The architects of the design group wanted a distinctive overhang as a part of the extrovert architectural expression. While overhangs may have some qualities, they tend to have a negative

effect on the daylight factor. A parameter variation of the length of the overhang was therefore made to inform the design decision. The result from this variation in Figure 33 shows that a 3 % daylight factor in the middle of the room is maintained with an overhang up to 1 meter.

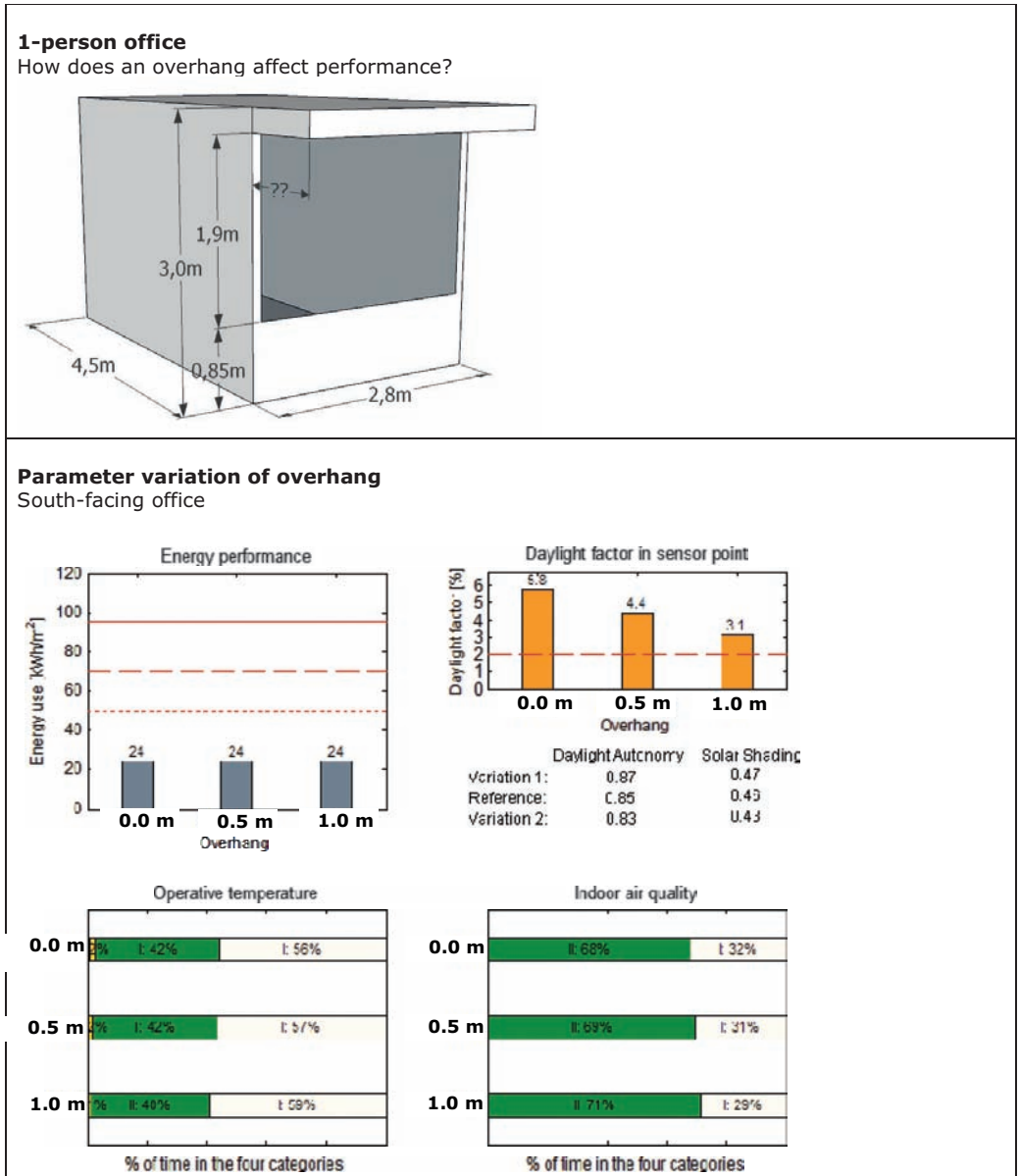

Figure 33. Parameter variation of length of overhang for a 1-person office.

A section of the final building design is shown in Figure 35, and Figure 35 is a compilation of illustrations of the final building design. These illustrations serve as an example of a total building design which has been established with the use of the output from the tool.

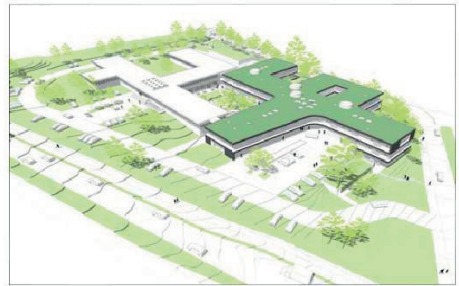

Figure 35. Illustrations of the total building design for Aarhus municipality.

5.1.3.1 Interview with architect

This section provides the essence from an interview with the architect who had the role of coordinating and integrating sustainability-related issues in the building design process, Kristian Nordheim from the architect company Pluskontoret A/S. The interview was conducted March 2011.

Question: *Please outline the general framework conditions of the building design process.*

Answer: There was a high ambition in the design brief regarding energy performance: 25 kWh/m² per year (author's note: this is the expected minimum requirement in the Danish building regulation in the year 2020). Furthermore, we were asked to rank our selves in a Danish 'light' version of the British sustainability rating system BREEAM.

We also had our own ambitions. From the very beginning of the project there was a consensus in the design group to focus on the use of passive means to reach the energy demand (author's note: the Danish building requirement allows building designers to compensate overstepping of the energy frame by subtracting renewable energy produced on-site, e.g. solar thermal and /or power). The main driver in establishing this consensus was the energy engineer who at the first design meeting presented an innovative ventilation concept (author's note: a so-called 'building integrated passive ventilation system' as described by Hviid in ref. [73]). We immediately saw some positive architectural knock-on effects in this concept. It became the backbone in the project from day one: we actually designed a lot of the building on the basis of this concept.

Question: *Can you give a short description of the design input provided by the energy engineer in the early building design phase?*

Answer: The energy engineer was very quick to provide an extensive daylight factor analysis of typical rooms of the building to illustrate the consequence of different façade concepts and room geometries. This was very valuable because the level of daylight was of high priority.

More generally, I really appreciated the energy engineer's ability to perform very quick energy and daylight analysis of our ideas and to follow that up with constructive design advice. Such analyses almost instantly gave us an outline of our design possibilities especially regarding e.g. window area, solar shading, size of overhang and orientation. It was the first and so far only time I experienced this kind of interaction with an engineer. Usually such calculations seem to take days.

Question: *Did you find the input useful in relation to the overall building design process?*

Answer: Yes, indeed. It was very useful. The input clarified a lot and helped us to move safely forward in a relatively fast pace. The input was to a certain degree actually generating the form of the building. For example, it is very satisfying that an architectural element such as the overhang also was optimised to have a positive (or at least neutral) effect on energy performance, daylight access and indoor environment.

Question: *Do you see a potential risk of information overload or limitation of architectural freedom?*

Answer: No, not really. In this project it was all basic information: how much glazing is possible, do we need a parapet, what about solar shading and overhang? Admitted, there were a number of rules to follow regarding the passive ventilation concept which had some influence on the overall layout of the building but it did not cause

any serious limitations in terms of architectural freedom. We were still quite free to shape the façade and internal flow.

But I think that it is very important that the energy engineer is present 'when it happens' and is able to explain and put the design input in to perspective. Architects easily get stuck when it comes to numbers and diagrams so personal guidance is important. I believe that multidisciplinary expert cooperation with mutual respect is the way forward in a world of increasing complexity.

Question: *Do you have any suggestions for improvements in relation to the simulation-based design input?*

Answer: Less numbers and graphs is always a good thing for the architect but I know it is difficult. The input is pretty technical but the graphical presentation is, however, interpretable and radiates trustworthiness. I think it is more essential that the engineer is present to explain it and update the calculations than making attempts to improve the architect's interpretation of the input.

Question: *What is your overall assessment of having simulation-based design support as input to the overall building design process?*

Answer: It is essential. Not only because it helps designers to meet a certain energy performance but also because the end product – the building – in many ways becomes a better design. The initial input is nice but the fact that input can be generated fast based on scarce information is good to maintain continuity and momentum in the often unpredictable conceptual design stage. An important prerequisite for all this is, in many cases, that the energy engineer is personally present and has the right tools at hand when conceptual design decisions are about to be made.

5.1.3.2 Test of *SH II*

In this section the data from the previous sections is used for testing *SH II*: *The output from the parametric analyses is useful in the overall building design process.*

Both the author's observations and the interview with the architect responsible for coordinating and integrating sustainability-related issues in the building design process shows that the design team to a wide extent found the input useful – especially when deciding on room geometries, the façade concept and overhang sizing. *The experiences from the Aarhus municipality project therefore corroborate SH II.* The quite solid corroboration of *SH II* is very much ascribed to the fact that all actors of the design team from the very beginning was in agreement regarding design goals, and agreed on a conceptual design process relying on a high level of multidisciplinary cooperation.

5.2 Master projects

The use of the tool constituted the core in two master projects from 2008. A short summary of the major outcomes relevant to the test of *SH II* is given in the following sections.

5.2.1 Master project 1

Leenknecht and Vandermaesen [74] used the tool in 2008 to design a low-energy office building. First, a number of rooms with an energy consumption of maximum 50 kWh/m² per year (50% lower than the minimum requirement in the Danish building code [75]) and a thermal and air quality class II according to EN 15251 [5] was generated. The suggested room designs were then used in the design of a four storey building. The rooms were treated as 'LEGO blocks', meaning that the building design process was a question of putting the rooms together to form a building. The floor plan and the whole building design are seen in Figure 36 and Figure 37.

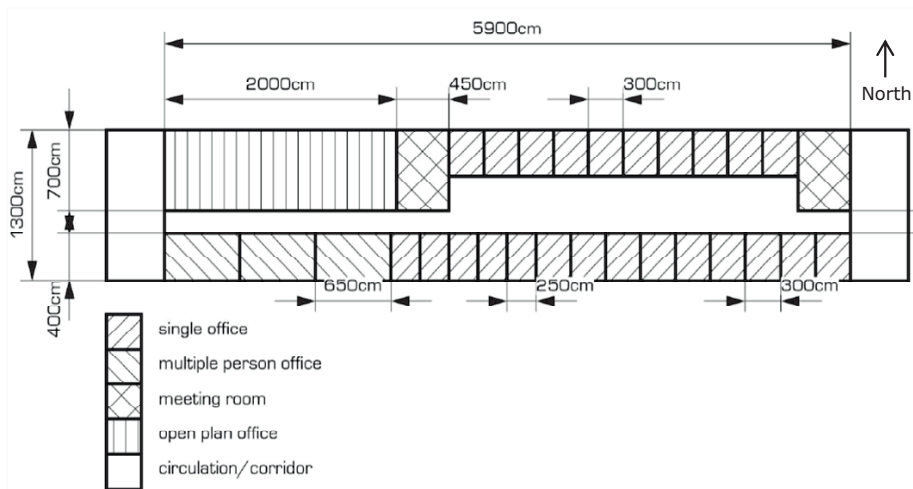

Figure 36. Typical floor plan with a total heated area of 3.068 m² (from Leenknecht and Vandermaesen [74]).

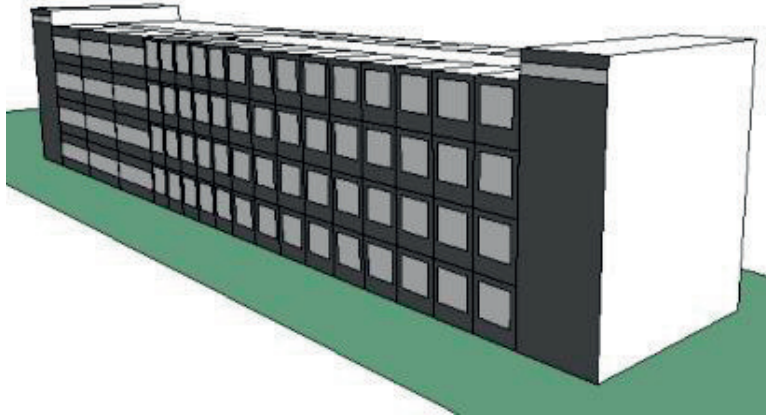

Figure 37. The whole building modelled in IES-VE (from Leenknecht and Vandermaesen [74]).

Based on the iDbuild simulations the total building energy consumption was estimated to be 34 kWh/m² per year. The sophisticated building simulation program IES-VE [37] was then used to optimise the design, especially the system controls, and the energy consumption was reduced to 19 kWh/m² per year. From this experience, Leenknecht and Vandermaesen conclude that the use of the design support generated with the tool in the initial design stage provides a good starting point for the detailed design and optimisation.

An important finding of this project was that better performance could be obtained by a finer seasonal differentiation of the temperature set point for cooling systems (mainly shading and ventilation). Traditionally, the year is considered two-seasonal. In other words, the year is often divided into a summer and a winter season with different acceptable thermal comfort ranges (according to EN 15251). There are therefore typically two different cooling set points: one for the summer situation and a different one for the winter situation. But an analysis in this master project indicates that better performance can be reached by dividing the control of building services into four seasons. The learning from this is that a two-season division may be too coarse for a temperate climate like the Danish where the energy demand may fluctuate between heating and cooling on a daily basis in the relatively long transitional periods between summer and winter (spring and fall). The question is whether the four-season division is sufficient or whether an even finer division would prompt even better performance. This is one of the issues investigated further in section 6.1 and Paper II in appendix A.

5.2.1.1 Test of SH II

The experiences from the two master projects actually gave evidence to test both SH I and SH II. In terms of SH I, the participants of both master project groups took the master course described in chapter 4 prior to their master project and were therefore experienced users of the tool. Their

familiarity with the tool led to increased operability but simulation time was still pointed out as an issue that compromised the operability of the tool. The projects also provided some interesting insights in terms of *SH II*. The adopted building design process in master project 1 (room designs were used as 'LEGO blocks' to generate an overall building design) seemed to be an efficient way of applying the design support to the building design process – at least in terms of reaching a very low-energy performance while maintaining a good quality of indoor environment. It is, however, noted that the project was a fictive building design project which did not involve an interdisciplinary design team. Consequently, any strong conclusion regarding the usability of the tool is not possible but the 'LEGO block' approach to building design indicates a diverse usability of the design support generated with the tool.

5.2.2 Master project 2

Jørgensen and Strømmand-Andersen [76] used the tool in 2008 to inform the design process of a real building design project in cooperation with a leading Danish architect firm. The initial focus of the architect was to establish an overall building geometry with no regard to energy performance and indoor environment. Parallel to this process, the two students used the tool to generate a vast amount of design options believing that no less would be perceived as a constraint of the architectural freedom. However, the amount of design options became so plentiful that the architects regarded it as information overload. It is therefore suggested that instead of generating a comprehensive solution space as input prior to any actual design decisions, the generation of a solution space should be a task involving the architects and only contain performance-decisive parameters essential to the overall architectural idea and concept. The end result was a building design with a predicted energy consumption of 50 kWh/m² per year and a predicted thermal and air quality in class II according to EN 15251 [5].

Figure 38 illustrates the statement from the master thesis that the proposals for room designs can be applied and used in different ways in the overall building design process. The figure could also be perceived as an illustration of the point put forward by architect professor Thomas Herzog in section 3.4, namely that good building design practice is to address the building scale and the room scale simultaneously.

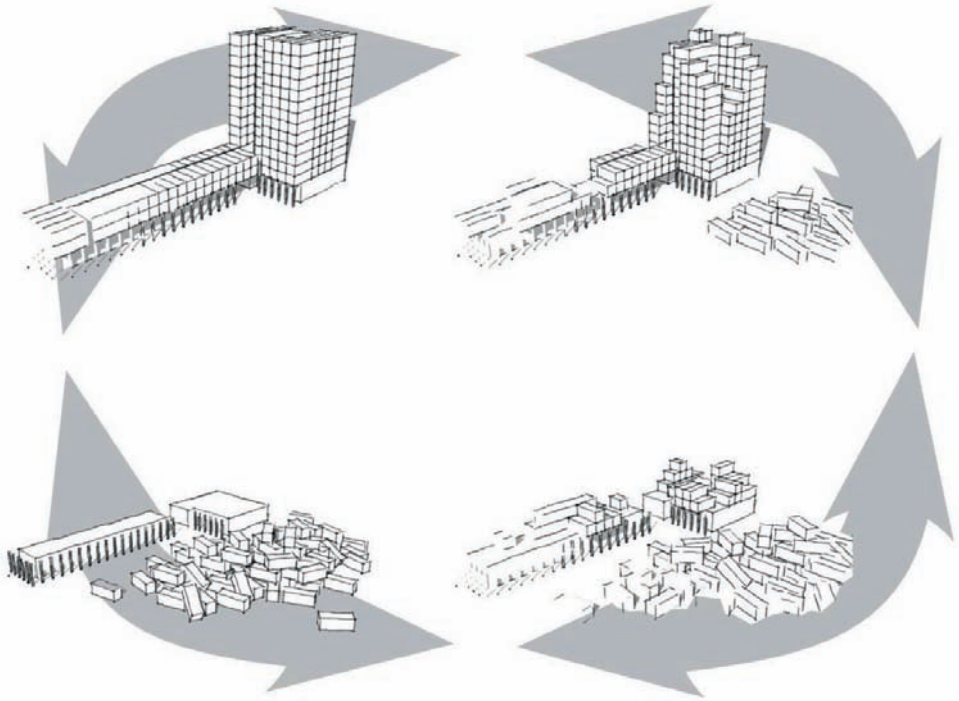

Figure 38. An illustration of the perception, that good building design practice is to address the building scale and the room scale simultaneously (from Jørgensen and Strømman-Andersen [76]).

The architect firm found that the subject of the project was important and needed to be investigated further. Therefore they hired both of the students to make two separate industrial PhD studies related to the subject of this thesis with the working titles 'Integrated energy design of large buildings' and 'Integrated energy design in master planning'. Both projects were initiated in 2008 and are expected to finish during 2011.

5.2.2.1 Test of SH II

The simulation-based design support generated with the tool was in this project perceived as useful even though it was first used after the establishment of an overall building design.

This master project was subject to the same process-wise challenges as the COM III project in section 5.1.1, namely that the architects were reluctant to include the students (engineers) in the conceptual stage of design because they expected that it would disturb their architectural freedom and process. When the students finally were allowed to present their rather vast amount of simulation-based design support generated with the tool, the architect did not feel constrained but on the contrary perceived it as information overload. In an attempt to make the simulation-based design support useful, the students and the architects started to work together on generating design options where only performance-decisive parameters essential to the overall

architectural idea and concept was investigated. This design support was perceived by the architect as useful.

The major experience from this master thesis is that the initial attitude of the actors of the design process, in this case the architect, is essential in terms of whether the simulation-based design support is perceived as a useful input to the overall building design process. Based on the experience of Jørgensen and Strømman-Andersen, it seems that a positive attitude towards the idea of using simulation-based design support as input to the overall building design process could be established by involving the architect more directly in the process of generating the design support.

5.3 Conclusion

This section provides an overall analysis of the three real building design projects and the two master projects in terms of *SH II*, from which a conclusion is derived.

The study of the real design projects shows that the design support generated with the tool indeed was influencing the early design decisions in both projects. There was, however, a difference in the extent to which the design support was allowed to influence the design. In COM III and master project 2 the design support was only allowed to influence the façade design whereas it also was allowed to influence the room geometries and the architectural programming in the Navitas and Aarhus municipality project. In relation to the aim and objective of this thesis, the latter extent of influence is the ideal. It is therefore in interest of the project to identify any reasons for this difference between COM III and master project 2, and the two other projects so that the usability of the tool and its output may be improved. Two major reasons were identified:

1. There was a reluctant attitude towards the idea of multidisciplinary collaboration in the early stages of design in the COM III project and master project 2 which was not present in the two other projects.
2. There was never consensus on the energy performance requirement in the COM III project because the architects were worried that this demand limited their architectural design freedom and the contractor was worried that such a building would not be buildable within the budget. In the two other projects, there was a strong and early consensus in terms the energy requirement.

The above issues are more related to the matching of expectations than the usability of the tool and its output. However, the issues should not be underestimated because it seems that the overall framework of the building design process and the attitude of the actors in the design team are essential – not only for the acceptance of the interdisciplinary, integrated design process as the work form – but also for the acceptance of simulation-based design support as an input to the actual form giving of the building.

Even though there was a difference in the extent to which the design support was allowed to influence the design process of the three real design projects, *the overall conclusion is that the tool and its output to a wide extent fulfils the criteria for a corroboration of SH II.*

The two master projects are representing two extremes in which the design support can be applied. The one project is composing room designs into a building design whereas the other project starts with the establishment of an overall building design solely with respect to an overall architectural idea. This also represents two opposite approaches to building design: an 'inside and out' approach and an 'outside and in' approach. The latter is the most common approach in real design projects. The COM III project is an example of this: functionality, flexibility and aesthetics on building level were solved prior to addressing other issues like energy performance and indoor environment. In comparison, the building design process of the Navitas and Aarhus municipality project was more a process of integrating two parallel activities, namely an 'inside and out' analysis using the tool and the more classic 'outside and in' analysis of the architect.

The three real design projects and the two master projects illustrates that the design support generated by the tool is adaptable to different building design approaches and can be applied at different design stages. This wide flexibility in usability is *a further corroboration of SH II.*

6 Advances in the development of the tool

This chapter summarises the documentation of the research conducted to develop new features to enhance its operability and usability of the tool described in chapter 3. A more detailed documentation is given in Paper II, Paper III and in Report I in appendix A.

6.1 Method for optimal control of building systems operation

A major finding from the observation of students working with the tool is that much time is spent on setting up appropriate controls for building systems operation. This is critical since the student tests also indicate that any features that may reduce time for setting up a model could increase the operability of the tool.

Because of their inexperience, the students typically had to go through a time-consuming iterative trial-and-error approach before an appropriate control for building systems operation was established – the very process that the tool was supposed to minimise (see paper I in appendix A). This is a main reason for suggesting a method for simulating predictive control based on weather forecasts. The overall aim is 1) to reduce time for setting up the building systems operation in the model, 2) reduce the number of simulations (iterations) needed before an appropriate setup is found, and 3) to investigate whether such a control would prompt better building performance compared to more traditional operation schemes.

Besides the above aims, the method is also considered a future design option. As for all alternative design options, it is desirable to know the impact of the suggested method before implementing it in an actual building design. The focus of the research is therefore also to describe the method so it can be implemented in an existing building simulation tool and used with design weather data.

This section summarises the documentation of the research conducted to develop a method for simulating predictive control of building systems operation in the design phase. A more detailed documentation is given in Paper II (see appendix A).

6.1.1 The method

The main problem for the students is to make an appropriate division of the year into seasons and to establish appropriate temperature set points for control of building energy management systems within these seasons. The task seems especially difficult when establishing control systems for night cooling to minimize overheating during day time. In the long transitional

periods²⁰ of the Danish climate the expedient control of building systems is challenging but also an area of potential energy savings. Leenknecht and Vandermaesen [74] identify a potential for energy savings and better indoor environment if the system control is divided into four seasons (winter/spring/summer/fall) instead of two seasons (summer/winter). However, an even finer division of time horizon for system control may be prompt better performance since the energy demand may fluctuate between heating and cooling on a daily basis in the spring and fall periods.

The suggested method for system control divides all days of the year in to two different time horizons, namely an in-use and an out-of-use period. The method then for each time step in a current period uses building simulation based on weather forecasts to predict whether there is a heating or cooling requirement in a subsequent period. This information enables the thermal control systems of the building to respond proactively in the current time step to keep the operational temperature of the subsequent period within the thermal comfort range with a minimum use of energy. See Paper II in appendix A for further details.

6.1.2 Reduction of time for setting up controls for building systems operation

The suggested method facilitates the setting of building energy management systems control. The user only has to set up two systems:

- *System 1* – which applies for the user-defined "Working hours"
- *System 2* – which applies for the "Non-working hours" (the remaining hours of the year)

The user then has to define 1) the minimum and maximum acceptance criteria for thermal comfort which apply for the entire year and 2) the control systems available in the two periods. As a consequence, the user only has to make half as many entries for setting up building systems control in a model compared to setting up a two-season model, and 1/3 as many compared to a four-season model.

Besides less time used on entries, the method also completely eliminates the need for iterations before an appropriate control for building systems operation is established. The reason is that temperature set points are automatically established and optimised within the method throughout the year. This automatically adjustment is also valuable when performing parameter variations for informed design decisions. A variation of geometry, building elements and systems may trigger a need for adapting the configuration of the building systems control to maintain thermal comfort and/or prevent unnecessary energy use. This adjustment may require a number of manual iterations before an appropriate configuration is found. Predictive control is automating this adaption and thus reduces the need for time-consuming iterations.

6.1.3 Performance of the method

The suggested method was implemented in the tool. A case featuring a single-sided, single-zone two-person office with a south-facing window located in Copenhagen, Denmark, is used to test

²⁰ Transitional periods are the periods of the year where the energy demand may fluctuate between heating and cooling on daily basis.

the performance of the concept. The occupied period is from 8 a.m. to 4 p.m. every weekday. The lower limit for thermal comfort is set to 20°C and the upper limit is set to 26°C. The impact of the suggested method was tested by comparing the results with two more traditional approaches for control of building system operation: a two season model where the year is divided into two periods in accordance with the Danish definition of heating and cooling seasons, and a four season model where the year is divided in four seasons to represent the long transitional periods in the Danish climate. The results from the test are shown in Figure 39 and Figure 40.

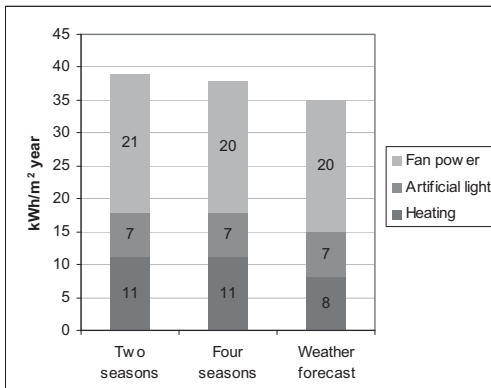

Figure 39. Annual energy consumption for heating, lighting and fans.

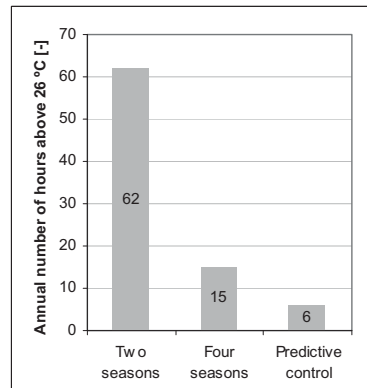

Figure 40. Overheating in the occupied hours. The recommended criterion for an acceptable number of hours outside the thermal comfort range is 108, according to EN 15251:2007.

The number of occupied hours with overheating was significantly reduced when the control of building system operation was divided into four instead of two seasons. The difference in energy demand is 1 kWh/m² per year for ventilation in favour of the four-season model. The suggested method based on weather forecasts reduces overheating compared to the two-season model as well as the four-season model. The suggested method also reduces the energy demand for heating and ventilation by 11 % and 7 % compared to the two- and the four-season model, respectively.

An interesting period of the year in relation to the performance of the method is the transitional period shown in Figure 41. Here the two-season model shifts from heating to cooling season with a fixed cooling set point of 20 °C, the four-season model has a fixed cooling set point of 23 °C, whereas the suggested method has a dynamic cooling set point. Figure 41 shows that the suggested method for building systems operation eliminates all overheating (temperatures above 26 °C) in the transitional period.

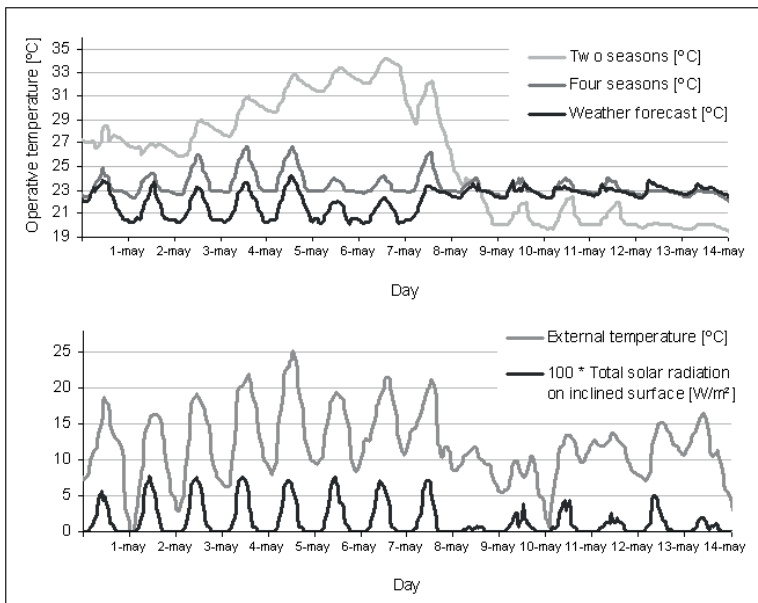

Figure 41. Transitional period. From Monday 30th April to Sunday 14th May, both days included.

6.1.4 Future work

The method is successful in terms of automating the configuration of building systems operation, thus facilitating the configuration of building systems operation when using the tool in the conceptual design phase. Furthermore it seems to prompt a certain level of energy savings and better indoor environment. There are, however, a number of issues that need to be addressed before applying the suggested method in a real building design.

First of all, the suggested method has a sequential approach to predictive control. This approach is different from current state-of-the-art approaches which tend to perform a global optimisation of all possible control actions over a certain prediction horizon (typically a day to a few days), e.g. in Henze et al [77] or the OptiControl project [78]. The global optimisation approach is quite well documented in terms of performance, whereas the performance documentation of the suggested method is limited to a single case example. So before continuing with the effort to implement the suggested method in a real building design, a more in-depth investigation of the performance of the suggested method and a comparison with global optimisation approaches is needed.

Besides the need to investigate the performance of the suggested method, there are a number of more general issues regarding predictive control that need to be investigated. The knowledge gap regarding the effects of deviations between modelled and actual conditions means that the jury is still out on the actual potential of predictive control. The response of the method to uncertainties in weather forecasts should therefore be examined e.g. by simulating with historical forecasts and corresponding observations instead of design weather data. Deviations between the

user pattern of the real building and the user patterns assumed in the simulation model should also be examined.

6.2 Method for economical optimisation in the design phase

An important factor in terms of improving the operability of the tool in the master course was to hand out predefined iDbuild simulation models as a starting point for the parameter variations. This evidently reduced the time-consuming iterative trial-and-error approach that the students usually had to go through before an appropriate starting point for parameter variations was established. The handing out of predefined models might be an immediate help for the untrained simulationist. The drawback is that the users of the tool are forced to depend and rely on the level of knowledge and experiences of the trained building simulationist, who generated the models. This dependency might be critical because the knowledge and experience of the trained building simulationist might not be up-to-date. For example, the level of knowledge and experiences may be appropriate to generate room designs with a predicted energy use of approximately 50 kWh/m² per year²¹ but not sufficient to generate designs which consume 'near zero energy' according to the newest version of EPBD [6]²². There is therefore a need for a method for establishing predefined models as a starting point for the parameter variations which can be managed without being dependent on third party knowledge and experience.

Another issue that such a method also could accommodate is the fact that increasing requirements for energy performance in new buildings mean that the cost of incorporating energy-saving in buildings is also increasing. Building designers thus need to be aware of the long-term cost-effectiveness of potential energy-conserving measures. It is therefore the intention to make a method for establishing a starting point for the parameter variations which besides fulfilling the energy requirement also has the lowest possible construction, maintenance and running costs. This is considered by the author to be a qualified estimate of an economically optimal solution – at least in terms of energy performance. The rationale for using this solution as a starting point for parameter variations is that energy engineer does not have to make a time consuming quest to find the 'optimal' solution²³. Instead, the energy engineer can concentrate on generating a range of possible solutions, i.e. solutions which fulfil requirement to the energy performance and to the quality of indoor environment, by using the tool as it is intended (see paper I in appendix A and chapter 3).

This section first summarises the documentation of the research conducted to develop a method for component-based economical optimisation for use in design of new low-energy buildings (see

²¹ This level of energy use is what is expected to become the minimum requirement in Denmark by 2015.

²² By 2020 all new buildings in the EU should consume 'near zero energy'.

²³ According to the data gathered in iterative tests of the tool (see chapter 4), there seems to be a strong urge amongst engineering students to use the parameter variations to optimise a single design rather than using them for generating a range of possible solutions.

Paper III in appendix A for details). Next, the method is positioned in relation to the tool and its intended role in the building design process.

6.2.1 The method

The method is based on the concept Cost of Conserved Energy (CCE) as it is defined by Meier [79]. The unit of CCE is 'cost per saved energy unit'. In the classic use of CCE for optimisation a measure is considered economically efficient if the CCE is lower than the weighted average cost of primary energy in the useful time of the measure. However, in the suggested method CCE is applied for optimisation in a somewhat different way.

The aim of the method is to enable designers to establish a good starting point for detailed economic optimisation and iterative design in e.g. iDbuild (Paper I in appendix A). The optimisation problem is divided into two levels:

- *Society level* – The economically optimal balance between the cost of saving energy and the cost of supplying renewable energy is used to set up the requirement for maximum energy use in buildings. The requirement is stated as an energy frame. The energy frame is a well-known concept for regulating energy efficiency on a societal scale, e.g. in the EU, where national energy requirements are based on energy frame according to the EPBD [4].
- *Building level* – The optimal solution is found by minimising the total cost of energy-saving measures constrained by the compliance of the energy frame. The method finds this minimum cost where the Cost of Conserved Energy in all the individual energy-saving measures is identical and minimised while fulfilling the energy frame.

The optimisation of a building design using the method suggested is thus a process of finding the combination of energy-conserving measures where the marginal CCE of the individual measures is identical and at the same time fulfils the energy frame. Continuous functions expressing the marginal CCE of an energy-conserving measure as a function of its energy consumption are applied to facilitate this process. The continuous functions enable the automation of the process of finding the optimal distribution of energy-conserving measures for the building design using a numerical solver. Energy-conserving measures can be divided in two types: measures with continuous energy properties (continuous measures) and measures with discrete energy properties (discrete measures). Optimisation of a continuous measure is a question of optimising quantity, e.g. the amount of insulation material in a construction or the size of a certain window component, whereas optimisation of a discrete measure is about evaluating the quality of the measure, e.g. a window component or a ventilation unit. Examples of the two types are seen in Figure 42 and Figure 43.

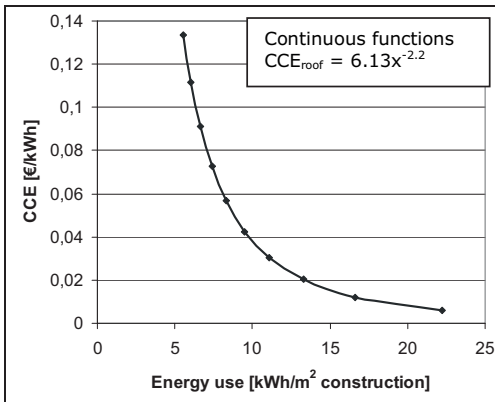

Figure 42. Example of a continuous function for a continuous measure.

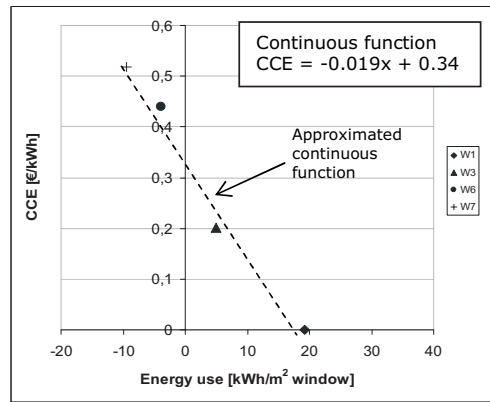

Figure 43. A continuous function based on discrete measures.

To find the optimal solution for the building as a whole continuous functions for all the main building elements and services are generated. The quantity of each building element and service is then stated, e.g. the area of the constructions and windows, the ventilation rate, etc. The functions are then used to find the optimal distribution of energy-conserving measures for the building design according to the criteria of the suggested optimisation method. The task can be facilitated, for example, by using the numerical solver in Microsoft Excel [80].

6.2.2 Case example

The feasibility of the method is illustrated by using a case example featuring a two-storey office building. Each floor is 500 m² (16 x 31.25 m) with a floor-to-floor height of 3.5 m. The window area constitutes 43% of the façade. The average mechanical ventilation rate is 1.2 ls⁻¹m⁻². Mechanical ventilation and lighting are only active on weekdays from 8 am to 5 pm. The building has to be optimised to fulfil an energy frame of 40 kWh/m² year. For the sake of simplicity, the optimisation is limited to the constructions (wall, roof and floor), windows, mechanical ventilation, and lighting. Furthermore, all maintenance costs are neglected. The result of the optimisation is seen in Figure 44.

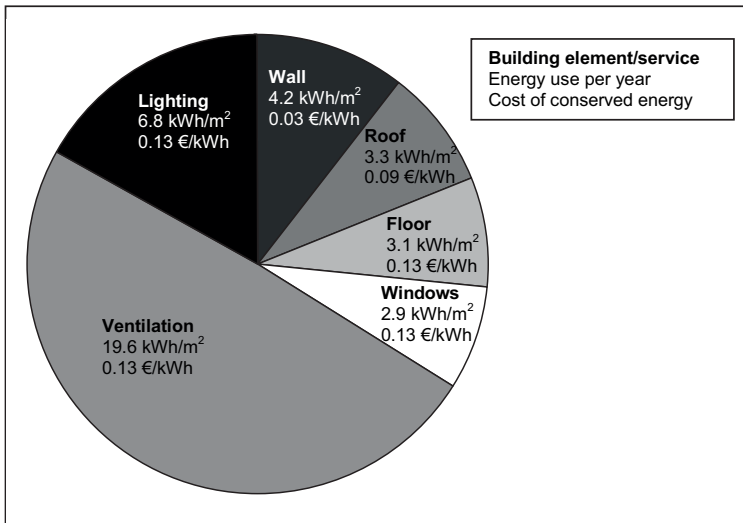

Figure 44. The distribution of the energy use in the economically optimal solution for the case example.

The CCE for the measures are not equal. The reason is that insulation level in wall, roof and floor was constrained to a maximum thickness of 0.3, 0.5 and 0.4 m, respectively. Optimising without such constraints results in excessive levels of insulation since the CCE for insulation in wall, roof and floor is significantly lower than for windows and services. Furthermore, the final solution must consist of available window components, ventilation and lighting systems. The optimised solution therefore has to be adjusted by choosing available components and systems which are closest to their optimised energy use. The adjusted solution has in this case an energy performance of 38.1 kWh/m² per year which is close to the energy frame of 40 kWh/m² per year. It is noted that the solution is only an estimate of an economically optimal energy solution, since the dynamic behaviour and interactions between energy-conserving measures are not taken into account.

6.2.3 The method in relation to the tool for simulation-based design support

The method is currently not an integrated part of iDbuild but the future perspective is 1) to automate the process of generating a room model which acts as a good starting point for the parameter variations, and 2) to use the method to add an economical dimension to the parameter variations and thus the informed design decisions. This section briefly outlines how and why the method could be an asset in relation to generating simulation-based design support in a tool such as iDbuild.

Initially, the method and the tool are used to generate a room model which acts as a good starting point for the parameter variations²⁴. The tool in combination with the method provides

²⁴ The definition of a good starting point is a room, which fulfils certain predefined requirements to energy performance and quality of indoor environment by using the mix of building components and services, which has the lowest construction and maintenance costs.

the ideal platform for generating such a starting point: integrated evaluations of energy performance and indoor environment quality for different measures are made with the tool, and the suggested method for economical optimisation is used for identifying and selecting the measures which as a whole constitute an optimal solution.

However, this solution is only an economical optimal solution in terms of fulfilling certain requirements for energy performance and indoor environment quality. There might be other issues, e.g. structural, fire and architectural issues, which need to be addressed before a room design in general is considered optimal/acceptable. Therefore the energy engineer should, in accordance with the overall idea of the tool²⁵, generate a number of possible solutions which fulfil the energy and indoor environment requirements. But instead of an arbitrary generated starting point for parameter variations, the energy engineer makes use of the optimal solution. After a number of parameter variations have been performed the backbone in the method for economical optimisation, namely Cost of Conserved Energy, is used to illustrate the energy-economical consequence of the parameter variations. It is now possible for the user to make informed design decisions which also include total energy-economic consequences. Finally, the proposals for room designs could be ranked in terms of energy-economical efficiency as an extra help for the subsequent building design process.

6.3 Modelling complex fenestration systems

The ability to predict the performance of complex fenestration systems (CFS) in the early design stage is of increasing interest: 1) because the annual feedback from the student project working with the tool and method expressed a desire to have CFS as a part of the solution space and 2) the use of uni-directional light transmittances in iDbuild is not accurate enough for CFS (see chapter 3.3).

This chapter describes a method for better prediction of the daylight performance of CFS such as daylight redirecting devices, novel solar blinds and advanced glazing materials. A more detailed documentation is given in Report I (see appendix A).

6.3.1 The method

As explained in section 3.3, the uni-directional representation of the properties of complex fenestration materials in LightCalc [65] is the reason for relative errors up to 35% compared to Radiance calculations. A more accurate characterization of the properties of complex shading devices is therefore needed. This section describes a daylight calculation method for determination of room illumination by fenestrations with a luminous intensity distribution represented by bidirectional transmission distribution function (BTDF) [81] [82]. The main idea is relatively simple:

²⁵ The overall idea of the tool is enable the energy engineer to generate simulation-based design support as input to the building design process prior to the actual form giving of the building.

Step1: The BTDF is transformed into bidirectional transmission coefficients (BTC)

The BTDF data can be transformed into bidirectional transmission coefficients (BTC) using formula (1) and (2) in Report I. It is provided that the experimental monitoring procedure of BTDF follows the discretation of the Tregenza scheme [84]. Alternatively, BTC can be produced directly from the Opticad-based BTDF generator developed by Moeller [85]. In this BTDF generator two Tregenza coordinate schemes are merged around a fenestration sample generating a set of BTDF arranged in the Tregenza scheme. This way the incoming light flux is entering the fenestration on the backside of the outgoing Tregenza scheme, see Figure 45.

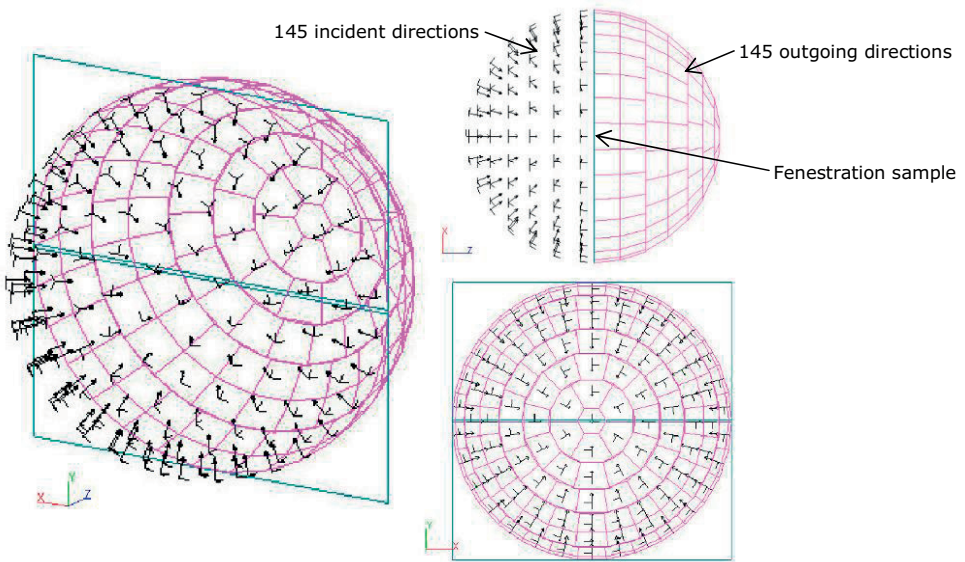

Figure 45. The BTDF sampling set up in OptiCad, to the left 3D and to the right 2D.

Step 2: A transmittance for each sky and ground patch is interpolated from the BTC data.

First, the spherical coordinates of the sky/ground vault, (r, θ_n, φ_n) , are converted to the coordinate system of the BTC, (r, θ_p, φ_p) . It is very unlikely that this coordinate is hitting the exact coordinate of a BTC coordinate. Instead, the incident direction may have up to four appurtenant Tregenza patches, see Figure 46.

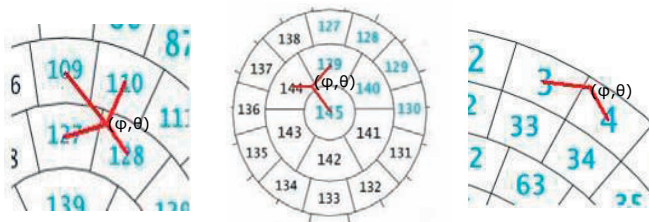

Figure 46. The three ways an incident direction (θ_s, φ_s) may intersect the Tregenza scheme.

In all three situations, a BTC for the incident direction is created as a weighted average of the BTC for the four neighbouring patches of the incident angle with respect to the orthodromic distances between the incidence direction and the centroids of neighbouring patches. The sun position (and its luminous intensity) now has its own BTDF.

6.3.2 Case example

The described method is implemented in the lighting simulation program LightCalc [65]. The implementation is not validated due to the deadline of this thesis. However, the result from a small test is shown to illustrate of the potential of the approach. The test features a BTC data set for a 2-layer glazing generated with the Opticad-based BTDF/BTC generator and a corresponding data set generated with WIS, see Report I for details. An immediate visual evaluation of the results from LightCalc simulations featuring the two data sets shows that the output is quite similar, see Figure 47. This was expected since the BTC and WIS data in table 1 in Report I are almost the same. By a closer look there are, however, three noticeable and potentially important differences:

- The illuminance levels close to the window are in general higher in the BTC results.
- The contours lines close to the window develops smoother in the BTC results.
- There seems to be a generally higher illuminance in the BTC model when comparing the contour lines of the two simulation outputs. A more detailed sampling shows that the BTC result for a specific point in the back of the room, $(x,y,z) = (2,5.5,0.85)$, has an illuminance level which is 7 lux higher compared to the WIS result, corresponding to a relative error of 2.7%.

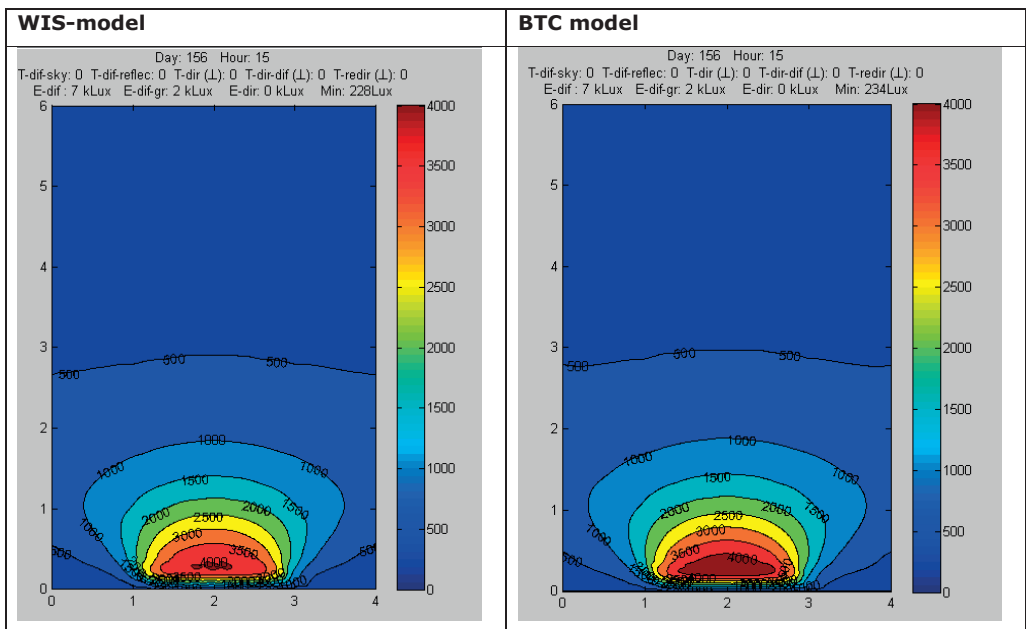

Figure 47. Results from simulations with WIS and OptiCad data.

7 Conclusion

The objective of this thesis was to test the hypothesis that *parametric analyses on the energy performance, indoor environment and total economy of rooms with respect to geometry and characteristics of building elements and services can be used to generate a useful input to the early stage of an integrated building design process.*

This chapter provides an assessment of the main hypothesis. Furthermore, the research contribution to academia and industry is stated, and directions for future work are suggested. Finally, the author of the thesis provides some concluding remarks to the findings of the thesis.

To facilitate the assessment of this hypothesis, two sub hypotheses were formulated and tested. It is the outcomes of these tests which now are used to make a qualified assessment of the main hypothesis. Therefore, these main outcomes are briefly summarised here.

- Sub hypothesis I was formulated with the aim to develop an operational tool for parametric analyses on the energy performance and indoor environment which can be used for generating input to the building design process. The keyword in this relation is *operational*.

Initially, a suggestion for such a tool was developed. The tool was then over a four year period developed according to the SER-model (see section 1.2.2) in a master course at DTU, where a total of 135 students were involved in the iterative, user-driven development with the aim to corroborate sub hypothesis I. The results from the final year of testing show relatively high rates of success in terms of generating a certain amount of room designs as input to the overall building design process. *The conclusion is that it is indeed possible to establish a tool for generating proposals for room designs as input to the overall building design process, and that the tool to a wide extent can be designated 'operational'.* It is noted that the notion of operability seems very much linked to the amount of time used on simulations. This time consumption is a combination of simulation time for a single variation and how many of these calculations that are needed before an appropriate amount of room designs are generated. The latter ('how many simulations') has been minimised by handing out predefined simulation model as starting point for the parameter variations.

- Sub hypothesis II was aimed at assessing whether the output from the parametric analyses is useful in the overall building design process. The keyword in this relation is *useful*.

The tool was used to generate design input to three real building design projects. The experience from all three projects was that the actors involved in general regarded the output from the parametric analyses as useful for making design decisions which, among other issues, also should pay regard to energy performance and indoor environment quality. There was, however, a difference in the extent to which the design input was allowed to influence design decisions. In one of the projects the design input was only allowed to influence design decisions regarding the façade, whereas the design teams of the two other projects to a wide extent allowed room geometries, architectural programming and façade design to be influenced by design input generated with the tool. The main reason was that the actors of the different design teams had different opinions on the benefits of interdisciplinary collaboration in the conceptual design stage, and different perceptions on whether the simulation-based design support is a constructive or limiting input to the actual form giving of the building. *The conclusion is that the output from the parametric analyses is useful in the overall building design process.*

Based on the findings from the tests of two sub hypotheses, it is concluded 1) that the tool and its output, with minor reservations and requisites, fulfils the criteria for a corroboration of sub hypothesis I (operability of tool) as well as sub hypothesis II (usability of output). Another reservation is that the addressing of the 'total economy' aspect of the main hypothesis has only been initiated in this research project. Consequently, the overall conclusion on the main hypothesis leaves the aspect 'total economy' out of account.

Bearing in mind the minor reservations and requisites for the corroboration of sub hypothesis I and II, and the fact that the total economy aspect has been left out, *the overall conclusion is that the tool fulfils the criteria for a corroboration of the main hypothesis.* This conclusion indicates that the use of the tool in the conceptual stage of the building design process is a potential means to reach the overall aim of this research project, namely to contribute to the implementation of low-energy office buildings with a high quality of indoor environment.

An outline of suggestions for future work on how to address the minor reservations and requisites in relation to sub hypothesis I and II, as well as the 'total economy aspect', is given in section 7.1.

7.1 Research contribution to academia and industry

The research findings reported in this thesis have contributions to academia as well as the industry. A list of the contributions generated by this PhD study is given in the following.

- **Contribution to academia**

The major contribution is a profound test of a building simulation tool, where the test results to a great extent corroborates the hypothesis that *parametric analyses on the energy performance, indoor environment and total economy of rooms with respect to*

geometry and characteristics of building elements and services can be used to generate a useful input to the early stage of an integrated building design process. It is noted that the analyses can be performed without having an overall building geometry as underlying basis. This illustrates that building simulation can be used to prescribe solutions rather than just evaluating solutions when designing buildings.

There are also a number of minor contributions which initially were developed with the aim to improve the operability of the above mentioned tool. They are minor because further work is needed to investigate their full potential. The minor contributions are listed in the following.

- A method fit for simulating predictive control of building systems operation in the design phase. The purpose of the method is to improve operability of the tool by automating the difficult task of configuring buildings systems operation in building simulation tools. Further work on many levels is however needed in this area, see section 6.1.
- A method for component-based economical optimisation for use in design of new low-energy buildings. The initial purpose of the method is to improve operability of the tool by automating the process of establishing a good starting point for parameter variations and to add an economical dimension to the informed design decisions. Further work is however needed in this area, see section 6.2.
- The basis for annual, hourly lighting simulations based on bi-directional transmittance distribution functions. Much work is needed in this area, see section 6.3.

- **Contribution to industry**

The major contribution to industry is a practicable tool for integrating the fulfilment of strict energy performance and indoor environment requirements in the conceptual design phase. The value and usability of the tool and its output is illustrated with the design of three low-energy office buildings, where the tool was used to generate input for design decisions in the conceptual design stage.

7.2 Future work

The research described in this thesis has resulted in a range of conclusions which may provide some insights useful to both academia and the building industry. However, it is also clear that future research is needed to further support some of the research findings.

7.2.1 Further development of the tool

The work described in chapter 3, 4 and 5 can be inspiring for further efforts to enhance the integration of the simulation tool into the building design process. With regard to the suggested tool there are tool-related as well as process-related issues to address. The most straightforward

tool-related issues are mainly to decrease simulation time, provide the ability to add more windows to the room, the ability to tilt windows, and to enable the performance calculation of more complex, innovative fenestrations. A more difficult task is to make more studies on the practical use of the tool to identify means that may enhance its usability in real design projects. One suggestion is to further integrate the tool with Google SketchUp to facilitate a design process where designers navigate back and forth between design at room level and design at building level.

In terms of the overall building process, there seems to be a need for research on *how* to make actors in the design team 1) accept the interdisciplinary, integrated design process as the general work form, and 2) trust that simulation-based design support is a useful input to the actual form giving of the building.

7.2.2 Weather forecast-based control of building systems operation

The performance of the sequential approach to predictive control should be tested on various building designs and the applicability of the method for different building types and climates, and the test result, should be compared to the performance of state-of-the-art global optimisation approaches. Further work is also required to assess the response of the method to uncertainties in weather forecasts and deviations between the user pattern of a real building and the user patterns assumed in the simulation model.

7.2.3 Economical optimisation method for the early design stages

The future perspective is to include the total economy aspect of the main hypothesis of this thesis in the tool by integrating the method in iDbuild with the aim to add an economical dimension to the parameter variations and thus the informed design decisions. Furthermore, it is the intention to improve the operability of the tool by making use of the method to automate the process of generating a room model which acts as a good starting point for the parameter variations. The implementation of the method should then be assessed in terms of operability and usability.

Furthermore, the method is currently only exemplified using a few performance-decisive parameters. Further work is required to include other parameters and energy-related issues such as geometry, the efficiency of heating and cooling systems, infiltration, and the effect of heat gains from people, equipment and lighting.

7.2.4 Annual, hourly lighting simulations based on BTDF

This research reported in this thesis provides the basis for annual, hourly lighting simulations based on bi-directional transmittance distribution functions (BTDF) in iDbuild. Much work has to be done to make BTDF in iDbuild operational, e.g. the method needs to be fully implemented for other sky models than an overcast sky, and detailed validation of output compared to RADIANCE calculations is necessary.

8 References

- [1] UN, Kyoto protocol to the United Nations framework convention on climate change, 1998
- [2] European commission, Climate change, ISSN: KH-30-08-690-EN-C, 2009
- [3] Communication staff working document accompanying document to the proposal for a recast of the energy performance of buildings directive (2002/091/EC) – Impact assessment, COM(2008) 780 final/SEC(2008) 2865, 2008
- [4] EPBD – Directive 2002/91/EC of the European Parliament and of the Council of 16 December 2002 on the energy consumption of buildings, 2002
- [5] EN 15251:2007. Indoor environment input parameters for design and assessment of energy performance of building-addressing indoor air quality, thermal environment, lighting and acoustics.
- [6] EPBD recast – Directive 2010/31/EU of the European Parliament and of the Council of 19 December 2010 on the energy consumption of buildings (recast), 2010
- [7] K. Popper, *The Logic of Scientific Discovery*, Routledge, London, 1959
- [8] J. Nielsen, Usability 101: Introduction to Usability, Bi-weekly web-column (no date), <http://www.useit.com/alertbox/20030825.html> (last accessed 1 March 2011)
- [9] G. Fischer, Rethinking Software Design in Participation Cultures, *Automated Software Engineering* 15 (3-4) (2008) 365–377
- [10] G. Fischer, Seeding, Evolutionary Growth and Reseeding: Constructing, Capturing and Evolving Knowledge in Domain-Oriented Design Environments, *Automated Software Engineering* 5 (4) (1998) 447–464
- [11] DTU course 11115: Building energy and technical services - Integrated design, <http://www.kurser.dtu.dk/11115.aspx?menulanguage=en-GB> (accessed 2011-02-15)
- [12] B. Lawson, *How Designers Think – The Design Process Demystified*, Architectural press, Oxford, MA, 1990.
- [13] C. Alexander, *Notes on the Synthesis of Form*, Harvard University Press, Cambridge, MA, 1964
- [14] B.L. Archer, Systematic methods for designers (1965), in N. Cross (ed.): *Developments in Design Methodology*, Wiley, Chichester, 1984, pp. 57-82.
- [15] M. Asimov, *Introduction to Design*, Englewood Cliffs, New Jersey, 1964
- [16] L.H. Sullivan, *Kindergarten chats and other writings*, Dover Publications, New York, 1979
- [17] Y.E. Kalay, Performance-based design, *Automation in Construction* 8(4) (1999) 395-409.

- [18] H.W. Rittel and M.M. Webber, Planning problems are wicked problems, in N. Cross (ed.): *Developments in Design Methodology*, Wiley, New York, USA, 1984, pp. 135-144.
- [19] R.B. Norman, Intuitive design and computation, in Y.E. Kalay (ed): *Principles of computer-aided design: Computability of Design*, Wiley-Interscience, New York, 1987, pp. 295-301
- [20] P.G. Rowe, *Design Thinking*, MIT Press, Cambridge, MA, 1987
- [21] J. Lang, *Creating Architectural Theory: The Role of Behavioral Sciences in Environmental Design*, Van Nostrand Reinhold, New York, 1987
- [22] O. Akin, How do architects design? in Latombe (ed): *Artificial Intelligence and Pattern Recognition in Computer-Aided Design*, IFIP, New York, 1978, pp. 65-119
- [23] H. Rittel, The state of the art in design methods, *Design Research and Methods (now: Design Methods and Theories)* 7 (2) (1973), 143-147
- [24] D. A. Schön, *The reflective practitioner: How professionals think in action*. New York: Basic Books, 1983
- [25] N. Cross, *Designerly ways of knowing*, Springer, London, 2006
- [26] N. Cross, Designerly Ways of Knowing: Design Discipline Versus Design Science, *Design issues* 17 (3) (2001) 49-55
- [27] A. Ward, Ideology, Culture and the Design Studio, *Design Studies* 11 (1) (1990) 10-16.
- [28] N. Cross, Forty years of design research, *Design Studies* 28 (1) (2007) editorial.
- [29] IEA task 23, *Integrated Design Process: A guideline for sustainable and solar-optimised building design*, International Energy Agency (IEA) Task 23 Optimization of Solar Energy Use in Large Buildings subtask B: Design process guideline, 2002
- [30] BC Green building roundtable, *Roadmap for the integrated design process*, Busby, Perkins+Will and Stantec Consulting, Vancouver, Canada, 2007
- [31] J.A. Clarke, *Energy Simulation in Building Design*, Butterworth-Heinemann, Oxford, 2001.
- [32] C.A. Morbitzer, *Towards the Integration of Simulation into the Building Design Process*, PhD dissertation, University of Strathclyde, Glasgow, UK, 2003
- [33] L.M.R. Prazeres, *An Exploratory Study about the Benefits of Targeted Data Perceptualisation Techniques and Rules in Building Simulation*, PhD dissertation, University of Strathclyde, Glasgow, UK, 2006
- [34] S. Citherlet, *Towards the Holistic Assessment of Building Performance Based on an Integrated Simulation Approach*, PhD dissertation, The architecture department, Swiss Federal Institute of Technology, Lausanne, Switzerland, 2001
- [35] F.C. Winkelmann, B.E. Birdsall, W.F. Buhl, K.L. Ellington, A.E. Erdem, J.J. Hirsch, S. Gates, *DOE-2 supplement, Version 2.2, LBL-34947*, Lawrence Berkeley National Laboratory, 1993
- [36] G.L. Ward, R.A. Shakespeare, *Rendering with Radiance – The Art and Science of Lighting Visualization*, second ed., Morgan Kaufmann, San Francisco, 1998
- [37] IES-VE, IES Ltd, <http://www.iesve.com>, Glasgow, 2010

- [38] K.P. Lam, N.H. Wong, A. Mahdavi, K.K. Chan, Z. Kang, S. Gupta, SEMPER-II: an internet-based multi-domain building performance simulation environment for early design support, *Automation in Construction* 13 (5) (2004) 651-663
- [39] ECOTECT, Autodesk Inc., www.autodesk.com/ecotect-analysis, 2010
- [40] M. Janak, Coupling building energy and lighting simulation, In: *Proceedings of the Fifth Building Simulation Conference (IBPSA)*, Prague, Czech Republic, September 8-10 1997
- [41] Energy Systems Research Unit, ESP-r, <http://www.esru.strath.ac.uk/Programs/ESP-r.htm>, University of Strathclyde, Glasgow, UK, 2005.
- [42] I. Beausoleil-Morrison, The adaptive coupling of heat and air flow modeling within dynamic whole-building simulation, PhD dissertation, University of Strathclyde, Glasgow, UK, 2000.
- [43] C.A. Hviid, T.R. Nielsen and S. Svendsen, Simple tool to evaluate the impact of daylight on building energy consumption, *Solar Energy* 82 (9) (2008) 787-798
- [44] T.R. Nielsen, Simple tool to evaluate energy demand and indoor environment in the early stages of building design, *Solar Energy* 78 (1) (2005) 73-83
- [45] T. Nielsen, T.R. Nielsen, S. Svendsen, Calculation of daylight distribution and utilization in rooms with solar shadings and light redirecting devices. In: *Proceedings of the Seventh Symposium on Building Physics in the Nordic Countries*, Reykjavik, Iceland, 2005, pp. 1011-1018.
- [46] U.S. Department of Energy, EnergyPlus Energy Simulations Software, www.eere.energy.gov/buildings/energyplus/
- [47] F. Bauman, B. Andersson, W. Carroll, R.C. Kammerud and N.E. Friedman, Verification of BLAST by Comparison with Measurements of a Solar-Dominated Test Cell and a Thermally Massive Building, *ASME Journal of Solar Engineering* 105 (2) (1983) 207-216
- [48] D.B. Crawley, J.W. Hand, M. Kummert, B.T. Griffith, Contrasting the capabilities of building energy performance simulation programs, *Building and Environment* 43 (4) (2008) 661-673
- [49] A.D. Radford and J.S. Gero, Tradeoff diagrams for the integrated design of the physical environment in buildings, *Building and Environment* 15 (1) (1980) 3-15
- [50] A. Mahdavi, V. Hartkopf, V. Loftness, K.P. Lam, Simulation-based Performance Evaluation as a Design Decision Support Strategy: Experiences with the Intelligent Workplace, In: *Proceedings of the Third Building Simulation Conference (IBPSA)*, Adelaide, Australia, 16-18 August 1993, pp. 185-191.
- [51] J.W. Hand, Removing barriers to the use of simulation in the building design profession, PhD dissertation, University of Strathclyde, Glasgow, UK, 1998.
- [52] G. Augenbroe, Building simulation trends going into the new millennium. Keynote. In: *Proceedings of the Seventh Building Simulation Conference (IBPSA)*, Rio de Janeiro, Brazil, August 13-15 2001, pp. 15-27
- [53] P. de Wilde, Computational Support for the Selection of Energy Saving Building Components, PhD dissertation, Delft University of Technology, Delft, the Netherlands, 2004

- [54] M.R. Donn, Simulation of imagined realities, PhD dissertation, Victoria University, Wellington, New Zealand, 2004
- [55] V.I. Soebarto, T.J. Williamson, Multi-criteria assessment of building performance: theory and implementation, *Building and Environment* 36 (6) (2001) 681–690
- [56] G. Augenbroe, P. de Wilde, H. J. Moona, A. Malkawi, An interoperability workbench for design analysis integration, *Energy and Buildings* 36 (8) (2004) 737–748
- [57] C. E. Ochoa and I.G. Capeluto, Advice tool for early design stages of intelligent facades based on energy and visual comfort approach, *Energy and Buildings* 41 (2009) 480–488
- [58] A. Ward, Ideology, Culture and the Design Studio. *Design Studies* 11 (1) (1990), 10-16.
- [59] L.B. McElroy, Embedding integrated building performance assessment in design practise, PhD dissertation, University of Strathclyde, Glasgow, UK, 2009.
- [60] W.G. Reed and E.B. Gordon, Integrated design and building process: what research and methodologies are needed?, *Building Research & Information* 28 (5-6) (2000), 325–337.
- [61] C.B. de Souza and I. Knight, Thermal performance simulation from an architectural design viewpoint, In: *Proceedings of the Building Simulation*, Beijing, China, September 03-06 2007, pp. 87–94.
- [62] Y.E. Kalay, Performance-based design, *Automation in Construction* 8 (4) (1999) 395-409
- [63] W.G. Vincenti, *What Engineers Know and How they Know It: Analytical Studies from Aeronautical History*, The Johns Hopkins University Press, Baltimore, 1990
- [64] H.M. Wadsworth, *Handbook of statistical methods for engineers and scientists* (2nd ed.), McGraw-Hill Professional, New York, 1997
- [65] C.A. Hviid, T.R. Nielsen and S. Svendsen, Simple tool to evaluate the impact of daylight on building energy consumption, *Solar Energy* 82 (9) (2008) 787-798
- [66] Danish Building and Urban Research, *BSim2002*, <http://www.bsim.dk>, Danish Building and Urban Research, Hørsholm, Denmark, 2003
- [67] IES Virtual environment program package, <http://www.iesve.com>
- [68] J. Nielsen, Success Rate: The Simplest Usability Metric, Bi-weekly web-column (February 18 2001), <http://www.useit.com/alertbox/20010218.html> (last accessed 21 February 2011)
- [69] H. Chignell, *Central Issues in Sociology*, Connect Publications, Cooksbridge (England), 1996
- [70] H.A. Landsberger, *Hawthorne Revisited*, Cornell University, Ithaca (N.Y), 1958.
- [71] SBI Direction 213, Danish Building Research Institute, Copenhagen, 2006
- [72] K. O. Thordardottir, Design and Control of LED-based Lighting System for Office Buildings, Master thesis, Technical University of Denmark, Lyngby, Denmark, 2009
- [73] C.A. Hviid, Building integrated passive ventilation systems, PhD dissertation, Technical University of Demark, Lyngby, DK, 2010.
- [74] S. Leenknecht and J. Vandermaesen, Methodology of integrated design of low-energy office buildings, Master thesis, Technical University of Denmark, Lyngby, Denmark, 2008

- [75] Danish Building Code, Bygningsreglement for erhvervs- og etagebyggeri (The Danish Building Code), Danish National Agency for Enterprise and Construction, Copenhagen, Denmark, 2006
- [76] M. Jørgensen and J. Strømmand-Andersen, Anvendelse og videreudvikling af metode til integreret design af større bygninger (English title: Application and development of method for integrated design of large buildings), Master thesis, Technical University of Denmark, Lyngby, Denmark, 2008
- [77] Henze GP, Felsmann C, Knabe G. Evaluation of optimal control for active and passive building thermal storage. *International Journal of Thermal Sciences* 2004;43:173–183.
- [78] Gyalistras D. Use of weather and occupancy forecasts for optimal building climate control (OptiControl). ETH Zurich; 2010.
- [79] A. Meier, What is the cost to you of conserved energy? *Harvard Business Review*, January-February (1983)
- [80] Excel (Part of Microsoft Office Professional Edition). Microsoft, 2003.
- [81] J.H. Klems, J.L. Warner, Measurement of bidirectional optical properties of complex shading devices. *ASHRAE Transactions* (1) (1995) 791-801
- [82] M. Andersen, M. Rubin, J-L. Scartezini, Comparison between ray-tracing simulations and bi-directional transmission measurements on prismatic glazing. *Solar Energy* 74 (2) (2002) 157-175
- [83] Commission Internationale de l'Eclairage, Radiometric and Photometric Characteristics of Materials and their Measurement, 2nd Edition, CIE 38 (TC-2.3), Paris (1977), 214 pp.
- [84] P.R. Tregenza, Subdivision of the sky hemisphere for luminance measurements. *Lighting Research and Technology* 19 (1) (1987) 13–14.
- [85] P. Moeller. Generating Bi-Directional Transmittance Function data in OptiCad for LightCalc. Master thesis, Technical University of Denmark, Lyngby, Denmark, 2009

Appendix A: Published or submitted papers

Paper I: Method and simulation program informed decisions in the early stages of building design

Published in *Energy and Buildings* 42 (7) (2010) 1113-1119



Contents lists available at ScienceDirect

Energy and Buildings

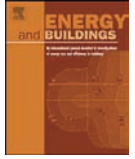
journal homepage: www.elsevier.com/locate/enbuild

Method and simulation program informed decisions in the early stages of building design

Steffen Petersen ^{*}, Svend Svendsen

Department of Civil Engineering, Technical University of Denmark, Brovej, Building 118, DK-2800 Kgs. Lyngby, Denmark

ARTICLE INFO

Article history:

Received 9 October 2009

Received in revised form 14 December 2009

Accepted 2 February 2010

Keywords:

Design process

Design tools

Energy performance

Indoor environment

ABSTRACT

The early stages of building design include a number of decisions which have a strong influence on the performance of the building throughout the rest of the process. It is therefore important that designers are aware of the consequences of these design decisions. This paper presents a method for making informed decisions in the early stages of building design to fulfil performance requirements with regard to energy consumption and indoor environment. The method is operationalised in a program that utilises a simple simulation program to make performance predictions of user-defined parameter variations. The program then presents the output in a way that enables designers to make informed decisions. The method and the program reduce the need for design iterations, reducing time consumption and construction costs, to obtain the intended energy performance and indoor environment.

© 2010 Elsevier B.V. All rights reserved.

1. Introduction

A rapidly growing demand for better energy performance in buildings is leading to an ongoing development of strategies and technologies to improve energy efficiency in construction without compromising on comfort, cost, aesthetics and other performance considerations. The European Performance Building Directive (EPBD) [1] reflects this need with a paradigm shift in regulations from individual component and system requirements to a framework for the total energy performance of the building. Choosing an appropriate combination of design options is thus a task of increasing complexity and cost. Creating an overview of possible design options and their performance is a critical task for building designers. There is a distinct risk of missing design opportunities which would have led to a better performance or obtaining undesirable effects if the design process is not properly informed. Making informed design decisions requires the management of a large amount of information on the detailed properties of design options and the simulation of their performance. Computer-based building simulation tools are ideal for this. However, Radfort and Gero [2] noted that the information provided by simulation tools is often evaluative rather than prescriptive. They argued that such tools are inefficient for the investigation of alternatives in the early stages of design, and they suggested a certain type and application of trade-off diagrams as a

way of applying computer assistance in the design process. There has been an undeniably rapid development in computer technology and an increase in the number of available building simulation tools in the decades since the realisations provided by Radfort and Gero, but even so their realisations are still remarkably relevant today. A study by Crawley et al. [3] summarises the development by describing 20 major building simulation programs. The study indicates, with a few exceptions like Energy-10 [4], a focus on the development and sophistication of detailed evaluative tools rather than prescriptive tools. The reason is that building simulation tools often are a product of research activities. Many available tools are developed by researchers, for research purposes. As a result, the tools are not easy to use, as they require a significant level of expert knowledge. But as performance issues like comfort and energy become increasingly important, the capabilities of building simulation are increasingly in demand to provide information for decision-making during the building design process. This need has started the development of design advice tools where the common objective is to facilitate the use of building simulation in the design process. The research in detailed evaluative tools is an important prerequisite for this development. For instance, some design advice tools, like the Building Design Advisor [5,6] and COMFEN [7], are developed to work as data managers and process controllers which utilise external detailed evaluative tools to provide design advice. Some existing detailed tools like Energy Plus [8] and TRNSYS [9] have an inbuilt feature to facilitate parametric runs which could be used for generating design advice. Other strategies adopted in the development of design advice tools include the integration of simple simulation models, e.g. the MIT

^{*} Corresponding author. Tel.: +45 45251928; fax: +45 45931755.
E-mail address: stp@byg.dtu.dk (S. Petersen).

Design Advisor [10], and the utilisation of expert and rules-based systems, e.g. NewFacades [11].

The currently available design advice tools tend to focus on the development of a platform for the evaluation of alternative designs rather than giving actual design advice. Just like conventional building simulation tools, they provide building designers with a predicted performance of certain designs but provide no constructive feedback in the event of undesirable performance. This forces the designer to perform design iterations until a satisfactory performance is reached. Reductions in the number of these time-consuming design iterations (reducing building design cost) could be achieved if building simulation was used more actively in the development of the design rather than for merely passive performance prediction. However, the successful integration of building simulation as an active design advisor requires in-depth understanding of the design process.

This paper is about the design theories and strategies used for the development of a method and an appurtenant building simulation program that can be used as an active design advisor in the early stages of design. The idea is to make use of a differential sensitivity analysis to illustrate how design parameters will affect the energy performance and the quality of the indoor environment prior to any actual design decision. This helps designers to pass from abstract design stages to more concrete ones with a conceptual solution which is aligned with the design intentions.

2. Method

The research in methods for structuring and managing the design process has been a field of interest since the 1960s. The body of research in this field is therefore vast. An overview of the development in design methods can be found in Ref. [12]. The general approach when it comes to the research in building design process is to divide the process into phases. The suggested amount, scope and naming of phases may vary, but in general the division can be summarised in three main phases with the following design tasks [13]:

1. *Conceptual design*—The initial problem-setting and creative phase.
2. *Main design*—More systematic analyses and tests, ending in a formal presentation of the design.
3. *Detail design*—Detailed documentation of the design.

This subdivision of the design process into phases is an attempt to ensure a certain progression in the development of the design. The output of a phase constitutes a number of constraints on the design tasks in the following phase. This subdivision of the design process might be convenient to ensure progression in the development of design at the project management level, but it does not provide designers with any explicit support in making better decisions in the actual design situation. A lot of design research is devoted to improving the ability of the designer. This research utilises various kinds of research methods, and investigations range from the more abstract to the more concrete [14]. One of the more recent and pragmatic outcomes is a paradigm called 'performance-based design' formulated by Kalay [15]. Kalay states that building design is an iterative process of exploration, in which alternative shapes for fulfilling certain functional traits are suggested and evaluated in a given context. Making an actual design decision relies on the designer's ability to explicitly represent, and then reflect upon, the desirability of the performance of a certain constellation of form, function and context. A major advantage of the performance-based design paradigm is that it is relatively easy to formalise as a practical workflow, see Fig. 1.

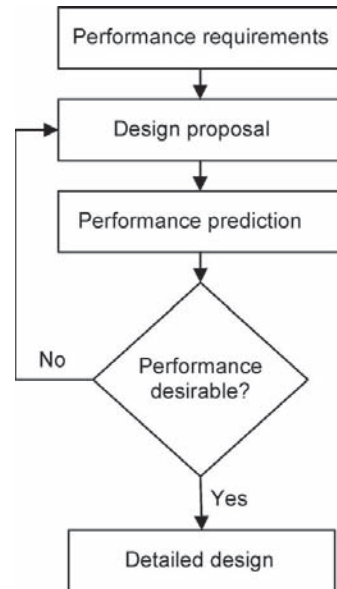

Fig. 1. The workflow and subtasks in performance-based design as described by Kalay [15].

The first task is to establish the performance requirements. The explicit definition of quantifiable performance requirements is the backbone of the performance-based design paradigm. Despite its importance the subject is not investigated further in this paper. Methods and experiences related to the translation of client and user requirements into assessable performance specifications can be found in Ref. [16]. The subtasks *design proposal*, *performance prediction* and *performance evaluation* constitute a loop of actions which ends the instant a desirable performance is reached. The whole process of going through the loop is called 'design iteration'. The presence of design iterations is not unusual in design processes. Steward [17] considered design iterations and defined the possible relationships between a pair of design tasks as independent (parallel or concurrent), dependent (serial or sequential) and interdependent (coupled). The need for design iterations emerges when design tasks are identified as dependent or interdependent. The design process contains different types of design iterations varying in scope, number and level in planning. The types of iterations can be categorised as intraphase or interphase [18]. Intraphase iterations are several rounds of dependent or interdependent design tasks within the same design phase. Interphase iterations are cross-phase, cycling around a range of design phases. The workflow in Fig. 1 is an attempt to improve the ability of the designer to facilitate the design activities in the conceptual design phase. The design iteration within the workflow is therefore an intraphase iteration.

The workflow in Fig. 1 is ideal for the integration of building simulation tools to predict the energy performance and the quality of the indoor environment of a design proposal. But while using simulation tools for performance prediction may provide information needed to decide whether the performance of a certain design proposal is desirable or not, it does not provide any design advice in the case of undesirable performance. The workflow therefore does not utilise the full potential of building simulation tools. With minor adjustments to the workflow of the performance-based design paradigm, building simulation tools could become an active

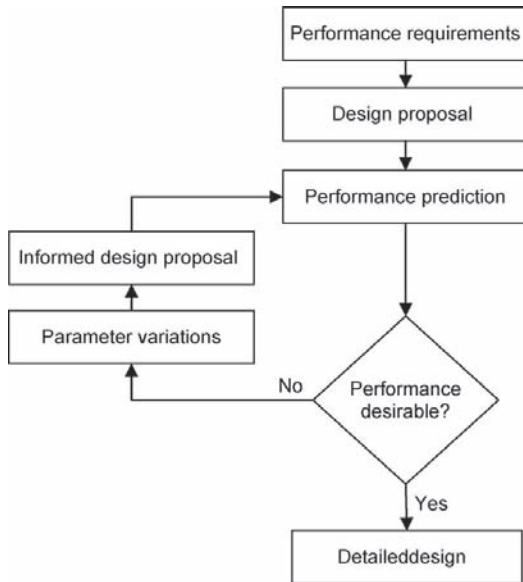

Fig. 2. The proposed expansion of the workflow of performance-based design.

driver in the development of the building design rather than just a powerful but passive way of predicting performance.

Using the workflow of Fig. 1, the building designer starts a design iteration by generating a design proposal, usually realised in the form of sketches and drawings of building plans, sections, elevations, etc., focusing on aesthetic and spatial performance requirements. The performance of the proposal is then predicted using various modelling and simulation techniques depending on the performances to be predicted. Whether a proposal satisfies the pre-established performance requirements then depends on the performance evaluation. If the evaluation shows that the proposed design does not fulfil the performance requirements, either it will be rejected or the designer can try to adjust it. The latter option is often taken and is a well-known but challenging task. There is a risk that designers, especially the inexperienced, in an attempt to satisfy one violated performance requirement make adjustments which then prove to cause the violation of a previously satisfied

requirement. In this case, the designer is forced to make another design iteration, which could in turn force yet another, and so on. The workflow in Fig. 1 can thus lead to a vast number of design iterations before a satisfactory solution is found. Every new design iteration is time-consuming. With the general time pressure in building projects, it is desirable to keep design iterations down. The number of design iterations could be reduced if designers had some knowledge of the consequences of their design decisions prior to making adjustments in the design proposal. In an attempt to include this kind of information in the design iterations, we add a new subtask called 'parameter variation'. This subtask goes in the design iteration loop right after a potential rejection of a design proposal, see Fig. 2.

Using the rejected proposal as a reference, the designer makes use of an appropriate building simulation tool to perform parameter variations of performance-decisive parameters such as room and window geometry, component properties, etc. It is suggested that a parameter variation is executed by changing only one input parameter at a time for each simulation while the remaining inputs stay fixed at their base case values. This approach is similar to differential sensitivity analysis (DSA) [19]. DSA enables the sensitivity of the program outputs to input parameter changes to be explored directly by the designer. This provides the designer with an overview of the consequences of adjusting a performance-decisive parameter in terms of energy performance and indoor environment prior to any actual design decision. With design decisions based on this overview, the new design proposal is more likely to fulfil the requirements with regard to energy performance and indoor environment in the following performance prediction and evaluation. Furthermore, the workflow minimises trial-and-error analyses and should reduce the number of design iterations.

The suggested adjustment to the workflow requires the use of an appropriate simulation tool. Besides being able to provide predictions on energy performance and the quality of indoor environment, this tool should be able to facilitate systematic parameter variations. Such a tool may provide a valuable platform for consequence-conscious design decisions, but the actual decision-making cannot be specified and delegated to others, let alone machines. Decision-making is a non-delegable design task and can only be addressed by the designer. This is the basis for the development of the iDbuild simulation program.

3. Description of simulation program

The aim of the iDbuild research and development effort is to operationalise the workflow of Fig. 2 in a software environment

Table 1
Input parameters for iDbuild. These are also the performance-decisive parameters which can be included in the generation of design advice.

Geometry	Constructions
<ul style="list-style-type: none"> • Room depth • Room width • Room height • Overhang • Window width and height • Height of frame construction • Window orientation • Window position in façade 	<ul style="list-style-type: none"> • U-value of opaque constructions • Thermal capacity of constructions • Thermal capacity of interior • Thermal, solar and visual properties of glazing • Thermal properties of frame construction
Systems and services	Energy supply
<ul style="list-style-type: none"> • Internal loads • Lighting • Ventilation: <ul style="list-style-type: none"> - Mechanical - Natural - Infiltration • Thermal set points, cooling season • Thermal set points, heating season 	<ul style="list-style-type: none"> • Thermal efficiency of heating system • COP cooling system • Solar water heating • Photovoltaic • Specific fan power for ventilation • Energy for services • Hot water consumption

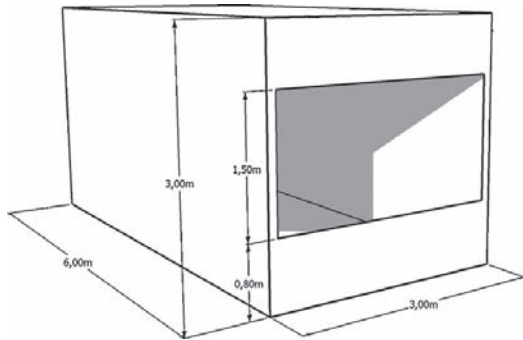

Fig. 3. Geometry the south-facing two-person office used in the example.

focusing on generating design advice regarding energy performance and the quality of indoor environment. One major objective is to provide this design advice without slowing down the flow of the creative process. The intention is that the program should work as a high-tech slide rule managed by the energy expert in the design team. The program should enable the expert to utilise the power of building simulation for the generation of design advice instead of slowing down the process with conventional evaluative simulations. The backbone of the program is the conflated version

of the simulation tools BuildingCalc [20] and LightCalc [21] called BC/LC. BC/LC can perform integrated performance predictions of energy consumption, thermal indoor environment, indoor air quality, and daylight levels. This simplified simulation model provides the fast performance predictions needed without compromising the precision of the output compared to more sophisticated simulation tools. The current limitation of BC/LC is that it can only make performance predictions of rectangular single-sided rooms with one window. Consequently, iDbuild can only generate design advice for this type of room. iDbuild is programmed in Matlab [22] and uses a graphical user interface to get input from the user and to provide results from simulations. The program is available in two versions: one to run in Matlab and one to run as a Windows program without Matlab. The former includes all the source code while the latter requires the installation of Matlab runtime libraries. Both program versions are available from the web address <http://www.idbuild.dk> or by contacting the corresponding author.

The facilitation of the suggested workflow through iDbuild starts by keying in an initial proposal for a room geometry which fulfils the pre-established spatial performance requirements. It is also possible to import the geometry of the room from the sketching software Google SketchUp [23]. Initial construction and building service properties are then defined. An overview of the specific input data needed for iDbuild is found in Table 1.

The performance of the room design is then predicted with BC/LC. In the following performance evaluation, the designer, or

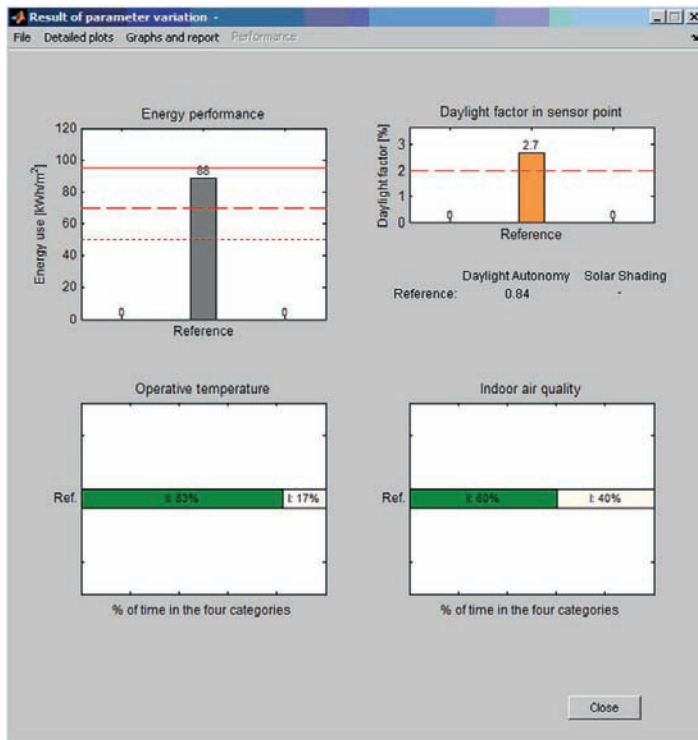

Fig. 4. Results from the performance evaluation of reference. Upper left: energy performance. Upper right: daylight factor, daylight autonomy in the occupied hours and the fraction of working hours in which solar shading is active. Lower left: thermal indoor environment. Lower right: indoor air quality.

design team, determines whether the performance is desirable or not. If the performance is undesirable, the designer can then use iDbuild to generate design advice through parameter variations using the initial design proposal as reference.

A parameter variation can be defined as the variation of one single parameter or a bundle of multiple parameters. The definition of a single parameter variation is an input value from the initial design proposal and two user-defined variations. Performing a single parameter variation will show how the alteration of a single parameter affects the performance of the design. For geometrical parameters, like window height, we recommend users set up a lower value and a higher value compared to the input value from the initial design proposal so that the output of the variation constitutes a tendency line giving the designer a wide solution space for an informed design decision. This is possible because the single parameter variation corresponds to a DSA where the underlying assumption is that the effect of a parameter variation is linear over the perturbation. A study conducted by Lomas and Eppel [19] shows that finite difference simulation programs essentially behave as linear and superposable systems. Basing a design decision on output from a DSA conducted in BC/LC is therefore considered as sufficiently accurate for the early stages of design. Other factors, like glazing components, are characterised by a number of interdependent properties which make their performance behave discontinuously. The output of such a variation is given as single, independent values. In some cases, it might be necessary to combine multiple input parameters to define the adjustment

fully. An example is the introduction of night ventilation combined with increased thermal capacity as an adjustment to reduce energy for cooling. The combination of parameters can be bundled and treated as one single parameter variation. A bundled parameter variation will show how the bundle of input parameters as a combination affects the performance of the design.

The user alone defines which and how many of the parameters from Table 1 to include in generation of design advice. The output of the parameter variations is given in accordance with the European directive EPBD [1] in terms of energy performance and indoor environment as defined in EN 15215:2007 [24]. How iDbuild presents the output of the parameter variations is best illustrated with a case study.

3.1. Case study

The objective was to design a south-facing two-person office in Danish climate. Besides the spatial needs of two people, the performance requirements are: (1) a thermal indoor environment and air quality which both as a minimum are within Class II of EN 15251:2007 [24]; (2) a daylight factor of 2% in the centre of the office; and (3) a maximum energy consumption of 70 kWh/m² per year measured in primary energy, which corresponds to low energy Class 2 in the Danish building code [25].

An initial shape which fulfils the spatial needs of two people in an office can be seen in Fig. 3. This shape was entered into iDbuild together with building component data, system data and energy

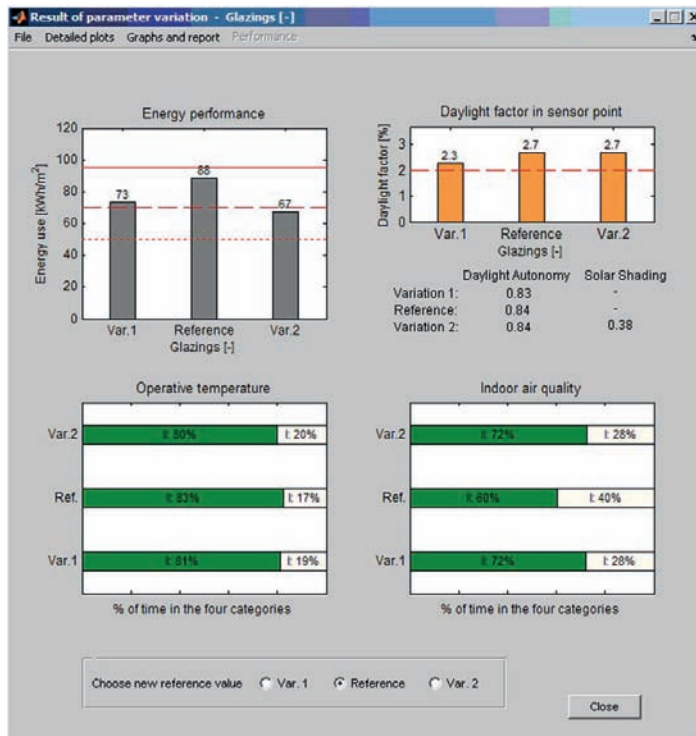

Fig. 5. Result from variation of glazing component. Var. 1: 2-layers with solar coating, reference: 2-layers with standard energy coating. Var. 2: 2-layers with standard energy coating with external, white blinds.

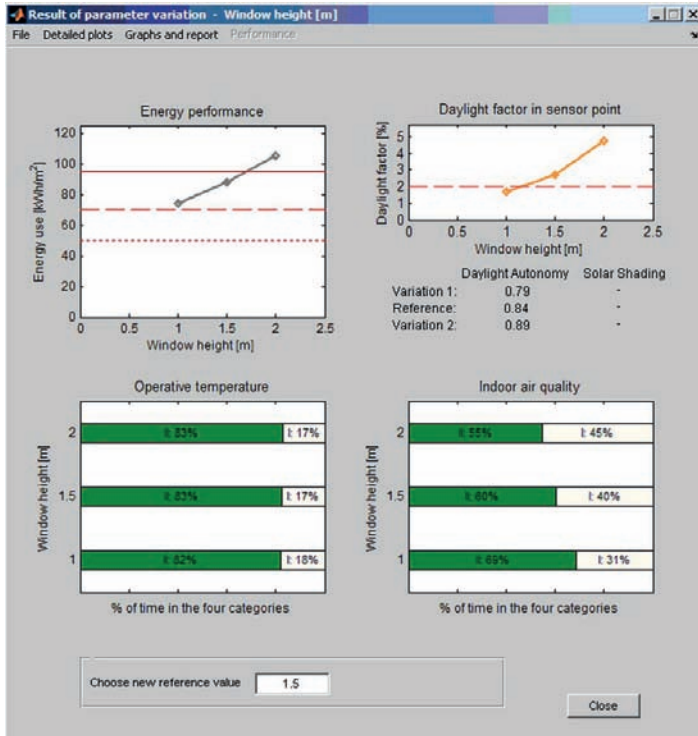

Fig. 6. Results from variation of window height. 2-Layers with standard energy coating (reference component in Fig. 3).

data in accordance with standard practice in Denmark. The output of the initial BC/LC simulation can be seen in Fig. 4. The conclusion of the performance evaluation was that the shape fulfils the performance requirements with regard to thermal indoor envi-

ronment, indoor air quality and daylight, but not with regard to energy consumption.

According to the workflow of Fig. 2, this meant that the next step was to perform parameter variations to form the basis for informed design decisions to remedy the problem. For the sake of simplicity, the parameter variations in this example were limited to considering only the type of window component and the height of the current window component. The output from the variations can be seen in Figs. 5 and 6.

Based on these parameter variations the designer could remedy the problem with energy performance without compromising the other performance requirements by: (1) choosing one of the two alternative glazings from Fig. 5; or (2) reducing the height of the reference window to 1.2 m according to Fig. 6.

The designer could also study more detailed outputs of the parameter variation before making any design decisions. Fig. 7 shows a more detailed statement of the energy consumptions for each of the parameter variations in Fig. 5. This enabled the designer to gain further insight into the energy-related consequences of the parameter variations. Furthermore, Fig. 8 could help the designer gain a deeper understanding of the annual daylight performance.

The designer then made an informed design decision and entered the decision in the bottom of the output overview; see Figs. 5 and 6. If the designer makes multiple informed design decisions, the program will make a new performance prediction of the room based on all the decisions and present the result as in Fig. 4. If the performance is desirable, the designer can move on to detailed design. If not, the designer can repeat the design loop.

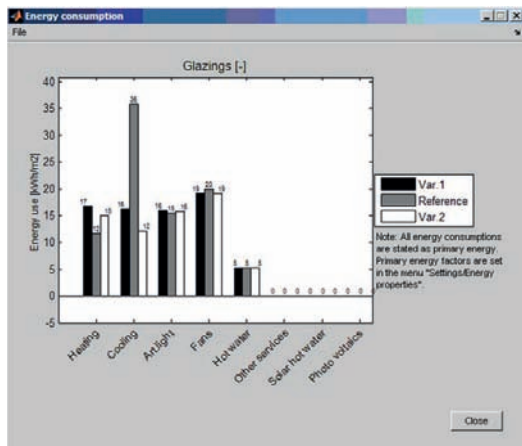

Fig. 7. Detailed statement of energy consumptions for each of the parameter variations in Fig. 5. The statement corresponds to the consumptions encompassed by the energy framework concept in EPBD [1].

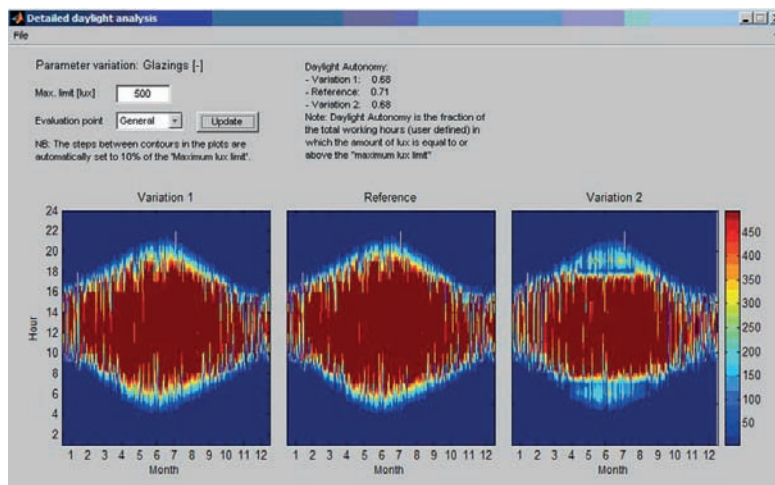

Fig. 8. Analysis of the annual daylight performance for the parameter variation of the glazing components from Fig. 5. The hourly daylight levels in lux are plotted for each month. The red areas indicate hours with a daylight level above 500 lx. (For interpretation of the references to color in this figure legend, the reader is referred to the web version of the article.)

4. Conclusion

The proposed method operationalised in the iDbuild tool helps designers to integrate the task of fulfilling energy and indoor environment performance requirements in all design decisions related to form, constructions and systems from the early design stages. By following the workflow of the suggested method, designers are less likely to waste time evaluating probable dead-ends, which is a risk in traditional trial-and-error approaches. Instead, iDbuild can be used for parameter variations generating an overview of how performance-decisive parameters affect the performance requirements. Basing design decisions on these overviews, the designer can make informed design decisions and reduce the need for time-consuming design iterations to achieve a particular performance.

The suggested method and tool has been developed to facilitate the design of rooms which fulfil certain performance requirements with regard to spatial needs, indoor environment and energy consumption. As such, it is a starting point for the development of an overall method for building design with the focus on minimising energy consumption without compromising functional needs and the quality of indoor environment. This development will aim at expanding the proposed method and tool to enable designers to navigate back and forth between design at room level and design at building level.

References

- [1] EPBD—Directive 2002/91/EC of the European Parliament and of the Council of 16 December 2002 on the energy consumption of buildings, 2002.
- [2] A.D. Radfort, J.S. Gero, Tradeoff diagrams for the integrated design of the physical environment in buildings, *Building and Environment* 15 (1) (1980) 3–15.
- [3] D.B. Crawley, J.W. Hand, M. Kummert, B.T. Griffith, Contrasting the capabilities of building energy performance simulation programs, *Building and Environment* 43 (4) (2008) 661–673.
- [4] The National Renewable Energy Laboratory with funding from the U.S. Department of Energy (DOE), ENERGY-10, <http://www.nrel.gov/buildings/energy10.html>.
- [5] K. Papamichael, Application of information technologies in building design decisions, *Building Research and Information* 27 (1) (1999) 20–35.
- [6] Building Design Advisor website, <http://gaia.lbl.gov/BDA/>.
- [7] COMFEN 1.0 website, www.windows.lbl.gov/software/comfen/1/index.html.
- [8] U.S. Department of Energy, EnergyPlus Energy Simulations Software website, www.eere.energy.gov/buildings/energyplus/.
- [9] University of Wisconsin, TRNSYS website, <http://sel.me.wisc.edu/trnsys/>.
- [10] The MIT design advisor, <http://designadvisor.mit.edu/design/>.
- [11] C.E. Ochoa, I.G. Capeluto, Advice tool for early design stages of intelligent facades based on energy and visual comfort approach, *Energy and Buildings* 41 (2009) 480–488.
- [12] N. Cross, Forty years of design research, *Design Studies* 28 (1) (2007), editorial.
- [13] L.E. Östman, A Pragmatist Theory of Design, PhD Dissertation, School of Architecture, Royal Institute of Technology, Stockholm, 2005, 394 pp.
- [14] N. Cross, *Designerly Ways of Knowing*, Birkhäuser, Basel, Switzerland, 2007.
- [15] Y.E. Kalay, Performance-based design, *Automation in Construction* 8 (4) (1999) 395–409.
- [16] D. Spekkink, Performance based design: bringing Vitruvius up to date, PeBBU Domain 3 Report, Rotterdam, 2005, 52 pp.
- [17] D.V. Steward, The design structure system: a method for managing the design of complex systems, *IEEE Transactions on Engineering Management* EM 78 (3) (1981) 71–74.
- [18] D.W. Unger, S.D. Eppinger, Planning Design Iterations, *Innovation in Manufacturing Systems and Technology (IMST) (2002)* Available from: <http://hdl.handle.net/172.1.1/4037>.
- [19] K.J. Lomas, H. Eppel, Sensitivity analysis techniques for building thermal simulation programs, *Energy and Buildings* 19 (1) (1992) 21–44.
- [20] T.R. Nielsen, Simple tool to evaluate energy demand and indoor environment in the early stages of building design, *Solar Energy* 78 (1) (2005) 73–83.
- [21] C.A. Hviid, T.R. Nielsen, S. Svendsen, Simple tool to evaluate the impact of daylight on building energy consumption, *Solar Energy* 82 (9) (2008) 787–798.
- [22] The MathWorks, 2008. Matlab and Simulink, Version R2007a, <http://www.mathworks.com>.
- [23] Google SketchUp, <http://sketchup.google.com/>.
- [24] EN 15251:2007. Indoor environment input parameters for design and assessment of energy performance of building-addressing indoor air quality, thermal environment, lighting and acoustics.
- [25] The Danish building regulations, Bygningsreglement for erhvervs-og etagebyggeri, National Agency for Enterprise and Construction, Copenhagen, 2006.

Paper II: Method for simulating predictive control of building systems operation in the early stages of building design

Published in *Applied Energy* 88 (2011) 4597–4606



Contents lists available at ScienceDirect

Applied Energy

journal homepage: www.elsevier.com/locate/apenergy

Method for simulating predictive control of building systems operation in the early stages of building design

Steffen Petersen*, Svend Svendsen

Department of Civil Engineering, Technical University of Denmark, Brovej, Building 118, DK-2800 Kgs. Lyngby, Denmark

ARTICLE INFO

Article history:

Received 27 January 2011
Received in revised form 4 May 2011
Accepted 28 May 2011
Available online xxx

Keywords:

Model-based control
Predictive control
Building systems operation
Energy savings
Building simulation

ABSTRACT

A method for simulating predictive control of building systems operation in the early stages of building design is presented. The method uses building simulation based on weather forecasts to predict whether there is a future heating or cooling requirement. This information enables the thermal control systems of the building to respond proactively to keep the operational temperature within the thermal comfort range with the minimum use of energy. The method is implemented in an existing building simulation tool designed to inform decisions in the early stages of building design through parametric analysis. This enables building designers to predict the performance of the method and include it as a part of the solution space. The method furthermore facilitates the task of configuring appropriate building systems control schemes in the tool, and it eliminates time consuming manual reconfiguration when making parametric analysis. A test case featuring an office located in Copenhagen, Denmark, indicates that the method has a potential to save energy and improve thermal comfort compared to more conventional systems control. Further investigations of this potential and the general performance of the method are, however, needed before implementing it in a real building design.

© 2011 Elsevier Ltd. All rights reserved.

1. Introduction

In the European Union (EU), the Energy Performance of Buildings Directive [1] has been introduced as a regulatory initiative to improve the energy performance of buildings. The building industry is thus obliged to produce buildings with low energy consumption during operation. At the same time, occupants have some expectations with regard to the thermal indoor environment which are the main reason for any heating and/or cooling energy demand. In a temperate climate like Denmark's, one of the consequences of low energy building design is that the heating period is decreased. This results in an increase of the transitional periods between the heating and cooling seasons. Transitional periods are the periods of the year where the energy demand may fluctuate between heating and cooling on a daily basis. Energy-efficient control of building systems operation in these periods is a challenge. One example is control of night ventilation in office buildings as a measure to prevent mechanical cooling in the day time. Buildings in a temperate climate are highly amiable to this type of free cooling and it is therefore an important measure in a low-energy design. Night ventilation is conventionally made available at a certain date

defined as the start of the cooling season, which ignores days in transitional periods when night ventilation might have been an energy-conserving measure. Another example is control of solar shading. Appropriate use of solar shading may prevent overheating but inappropriate use may increase heating requirement due to loss of solar gain and increased use of electrical lighting. The development of new concepts for the control of building systems operation is therefore needed to minimise energy demand while maintaining comfort.

The current research efforts on improving control of building systems evolve around the concept of predictive control. Much of the current research on predictive controllers is based on stochastic models [2,3], fuzzy logic control [4–6], or neural networks [7–10]. Common for these approaches is that they have no underlying physical model of the system and process being controlled. Instead these so-called “black-box” models use observed data, e.g. outdoor temperature, etc., as input to a statistically derived model which maps input to variables of interest, e.g. the indoor operative temperature. With the proper training these models may over time obtain the sufficient knowledge regarding the interactions between the elements of the controlled system or the interactions between the controlled system and the outdoor climate to make appropriate predictions. The limitations are that the training needed often is extensive, and that they may not provide reliable predictions in areas in which they were not trained [11]. Clarke et al. [12] consider these limitations as a crucial argument for the use of

* Corresponding author. Tel.: +45 45251928; fax: +45 45931755.
E-mail address: stp@byg.dtu.dk (S. Petersen).

Nomenclature

n	the current time step (–)	T_w^*	predicted internal wall temperature at the end of the period to which time step n belongs ($^{\circ}\text{C}$)
Q_{sun}	actual average solar irradiance in time step n (W/m^2)	$T_{a,0}$	actual air temperature at the beginning of time step n ($^{\circ}\text{C}$)
Q_{sun}^*	hourly forecast of solar irradiance of the remaining hours of the period to which the time step n belongs (W/m^2)	$T_{w,0}$	actual wall temperatures at the beginning of time step n ($^{\circ}\text{C}$)
$Q_{sun,av}^*$	mean forecasted solar irradiance of the remaining hours of the period to which the time step n belongs (W/m^2)	$T_{a,0}^*$	predicted air temperature at the beginning of the following period ($^{\circ}\text{C}$)
Q_{sun}^{**}	hourly forecast of solar irradiance for the following period (W/m^2)	$T_{w,0}^*$	predicted wall temperatures at the beginning of the following period ($^{\circ}\text{C}$)
$T_{c,min}$	minimum temperature for thermal comfort ($^{\circ}\text{C}$)	T_{op}	actual operative temperature in time step n ($^{\circ}\text{C}$)
$T_{c,max}$	maximum temperature for thermal comfort ($^{\circ}\text{C}$)	T_{op}^*	predicted operative temperature at the end of the period to which time step n belongs ($^{\circ}\text{C}$)
$T_{c,av}$	mean value of temperatures for thermal comfort ($^{\circ}\text{C}$)	T_{op}^{**}	the maximum predicted operative temperature in the following period ($^{\circ}\text{C}$)
T_{out}	actual outdoor temperature in time step n ($^{\circ}\text{C}$)	T'_{op}	operative temperature in time step n with $hr, shd, mvent$ and/or $nvent$ ($^{\circ}\text{C}$)
T_{out}^*	hourly forecast of outdoor temperature of the remaining hours of the period to which time step n belongs ($^{\circ}\text{C}$)	$T_{set,cool}$	cooling set point for time step n ($^{\circ}\text{C}$)
$T_{out,av}^*$	mean forecasted outdoor temperature of the remaining hours of the period to which time step n belongs ($^{\circ}\text{C}$)	$T_{set,heat}$	heating set point for time step n ($^{\circ}\text{C}$)
T_{out}^{**}	hourly forecast of outdoor temperature of the following period ($^{\circ}\text{C}$)	$T_{set,cool}^*$	predicted cooling set point for time step n ($^{\circ}\text{C}$)
T_s	actual wall surface temperature at the end of time step n ($^{\circ}\text{C}$)	hr	heat recovery rate for mechanical ventilation system (–)
T_a	actual air temperature at the end of time step n ($^{\circ}\text{C}$)	shd	predicted solar shading factor (–)
T_a^*	predicted air temperature at the end of the period to which time step n belongs ($^{\circ}\text{C}$)	$mvent$	predicted mechanical ventilation rate (l/s per m^2)
		$nvent$	predicted venting rate (l/s per m^2)

physically-based models, or “white-box” models, in the development of predictive control instead of black-box models. They suggest a control concept based on a detailed building simulation program to make real-time control decisions. They demonstrate the feasibility of the concept by making a reasonable prediction of the optimum start time for a heating system in a test case. Mahdavi [13] also suggests the use of building simulation for predictions to enhance the control of building systems operation. The overall concept is to utilise a virtual building model to move forward in time to predict the building’s response to alternative control scenarios, and use actual recorded data to calibrate the virtual model to improve its predictive potential. Mahdavi [14] has also developed a controller for simulation-based real-time control of lighting and shading systems. Tests of the controller prototype show promising results in terms of recommending appropriate real-time control states. Henze et al. [15,16] apply building simulation and weather forecasts for predictive control of cool storage systems in office building. Test cases in both references demonstrate a potential for substantial reductions in utility cost and cooling-related on-peak electrical demand in a subtropical arid climate. Wittehen et al. [17] also apply building simulation and weather forecasts to predict appropriate set points and air flows in the control of night ventilation. A test case featuring a building in a temperate climate indicates a theoretical annual energy saving of 5% and improvements in the thermal indoor climate compared to a conventional control system. The Model Predictive Control algorithms developed in the 3 year long interdisciplinary project Opti-Control indicates a theoretical energy saving potential of 16–41% varying with location (in central and south Europe), building case, and technical system characteristics [18]. Coffey et al. [19] presents a software framework what could be characterised as a “grey-box” approach to predictive control since it combines physically-based models with a generic (stochastic) algorithm. The results from a case study demonstrate that the framework can be used to minimise cooling demand through optimal demand response using zone temperature ramping in an office space.

So, current predictive control systems have demonstrated a potential for energy savings and improvements in thermal indoor environment and visual comfort. Predictive control is therefore a potential energy-saving design option when designing new low-energy office buildings. As for all alternative design options, it is desirable to know the impact of predictive control before implementing it in an actual building design. Furthermore, the use of a predictive control could become a facilitating feature in a building design process where building simulation is used to generate design input through parametric analysis of energy performance and indoor environment by varying geometry, building elements and systems, e.g. as described by Petersen and Svendsen [20]. A variation of geometry, building elements and systems may trigger a need for adapting the configuration of the building systems control to maintain thermal comfort and/or prevent unnecessary energy use. This adjustment may require a number of manual iterations before an appropriate configuration is found. Predictive control is automating this adaption and thus reduces the need for time-consuming iterations. This automatic adaption is also relevant in actual building systems operation. Conventional control of building systems are mainly rule-based or reactive, i.e. controlled with respect to real-time measurements of internal conditions and external gains. The consequence is a risk of discomfort and increased use of energy, especially in the fluctuating transitional periods. These problems could be minimised by using a predictive control system which enables the building systems control to react proactively to an energy demand that may fluctuate between heating and cooling on a daily basis. The aim of this paper is therefore (1) to enable building designers to predict the annual performance of a predictive control system in the early stages of building design, (2) facilitate and automate the configuration of the building systems control when performing parametric analysis in the early stages of building design, and (3) to make an initial investigation of the method’s potential for energy savings and thermal comfort improvements. The scope of these aims is limited to apply for office buildings only.

2. Method

2.1. Requirements for the simulation tool

The suggested method is developed for implementation in a building simulation tool which is able to perform dynamic simulations, i.e. take the time constant of the building into consideration. The tool must as a minimum be able to calculate in hourly steps and provide values for the internal surface temperature of constructions, the air temperature, and the energy demand to maintain thermal comfort. However, such a tool can only make control decisions based on an evaluation of the thermal performance. Control decisions based on an integrated evaluation of lighting and thermal performance can be obtained if the tool is also able to perform hourly daylight simulations for control of artificial lighting and blinds (visual comfort), and is able to link this to the thermal simulation.

2.2. User input

Besides the user inputs needed to define the building simulation model, the suggested method has some specific additional input requirements. The method requires that the user defines in-use periods, i.e. the periods where there are people present in the building, for example from 8 a.m. to 4 p.m. every day of the week except Saturday and Sunday. All other periods will be considered as out-of-use periods, i.e. periods where there are no people present. The distinction between in-use and out-of-use periods is essential in office buildings where a combination of ventilation and exposed thermal mass in out-of-use periods (night time) is used to minimise cooling demand in in-use periods (daytime). More precisely, the distinction allows ventilation inlet temperatures for efficient night cooling which would have prompted a notion of discomfort in the daytime. It is acknowledged that other types of buildings, e.g. dwellings, might require a different distinction. Further elaboration on this matter is not given in this paper as the scope of the method currently is limited to apply for office buildings only.

The user also has to define (1) the thermal control systems available in the two periods and (2) the minimum and maximum acceptance criteria for thermal comfort, $T_{c,min}$ and $T_{c,max}$ respectively, which apply for the entire year. The premise of a single comfort range covering the entire year requires further explanation in order not to conflict with the ruling standards for thermal comfort. The European standard for indoor environment, EN 15251 [21] states temperature ranges for different levels of user expectation. Since building occupants are expected to wear different levels of clothing depending on the season, the comfort ranges are subdivided into a range for the heating period (winter) and a range for the cooling period (summer). For example, the ranges for a thermal indoor environment in Class II is 20–24 °C in the heating period assuming a clothing of 1 clo, and 23–26 °C in the cooling period assuming a clothing of 0.5 clo. In this instance, the appropriate input for the method we are suggesting would be to use the lower limit for the heating period as $T_{c,min}$ and the upper limit for the cooling period as $T_{c,max}$. The comfort range thus becomes 20–26 °C for the entire year. As a consequence, the thermal indoor environment can only comply with EN 15251 if it is assumed that the occupants use clothing for adaptive thermal control. For example, if the building is cooled to 20 °C during the night to prevent overheating the next day, occupants are encouraged to have a clothing of 1 clo in the morning, which they are able to change to 0.5 clo if the temperature rises above 24 °C during the day. The major advantage of this is that it eliminates the task of defining the start of the cooling and heating seasons. Instead of relying on speculations regarding the start date of the cooling and heating

season (which corresponds to seasonal dictation of occupant clothing level), the suggested method automatically activates the appropriate control strategy depending on whether there is a future cooling or heating requirement.

2.3. Weather data input

The weather forecast needed in the method is best explained with an example. Let the current time step n be at the beginning of an out-of-use period, e.g. 5 p.m. on 15 March. The task is then to use a weather forecast to predict whether there is a heating or cooling requirement during the following in-use period, e.g. from 8 a.m. to 4 p.m. on 16 March. The weather forecast must thus contain hourly values of solar radiation, Q_{sun} , and outdoor temperature, T_{out} , for the building location and cover the remaining hours of the current out-of-use period as well as the hours in the following in-use period, i.e. the 24 h from after 4 p.m. on 15 March to 4 p.m. the 16 March. In actual building operation the weather forecast should be updated before calculation of time step $n + 1$ (6 p.m. on 15 March) and the conditions of the historic time step n should be re-simulated using the actual weather data and system settings for time step n . This update is not possible when performing simulations in the design process of the building. Instead weather forecasts are established by looking forward in the design weather data file. This is an ideal weather forecast (no deviation between weather forecast and actual weather) since the weather data file also represents the actual weather.

2.4. Description of the suggested method

The description of the method is divided in two parts: (1) a prediction part which describes the prediction of an appropriate system control strategy, and (2) a testing part which describes how the method tests whether the predicted system control strategy is able to maintain the operative temperature within the thermal comfort range in each time step of the current period. If not, the system control strategy is revised.

2.4.1. Prediction

The prediction part of the method is a set of fictive performance simulations with the purpose of finding the appropriate cooling set point and a suitable system control strategy to reach this cooling set point at the end of a period. The simulations performed here have no influence on the actual energy balance of the simulation model: the actual performance simulation is made in the testing part, see Section 2.4.2. This allows us to make certain assumptions in the process of establishing the appropriate control strategy. First the initial air and internal wall temperature at the beginning of the first time step of the period following the period to which n belongs ($T_{a,0}^*$ and $T_{w,0}^*$) are predicted, see Fig. 1. The period, in-use or out-of-use, to which n belongs is henceforth called the *current period*. The period following the period to which n belongs is henceforth called the *following period*.

Fig. 1, Item (1): The hourly weather forecast data for the remaining hours of the current period, Q_{sun}^* and T_{out}^* , are used as input to calculate the operative temperature, T_{op}^* , the air temperature, T_a^* , and the wall temperature, T_w^* , at the end of the current period. The calculation is performed in free-floating. This means that T_a^* , T_w^* and T_{op}^* are only influenced by the weather data, the minimum user-defined system values (ventilation, lighting, internal loads, etc.) and the energy properties of the building constructions. If the ventilation system is active in time step n the supply air temperature is the same as the outdoor temperature.

Fig. 1, Item (2): The initial air and wall temperatures at the beginning of the *following period*, $T_{a,0}^*$ and $T_{w,0}^*$, are determined based on the outcome of Item (1). In principle $T_{a,0}^*$ and $T_{w,0}^*$ are

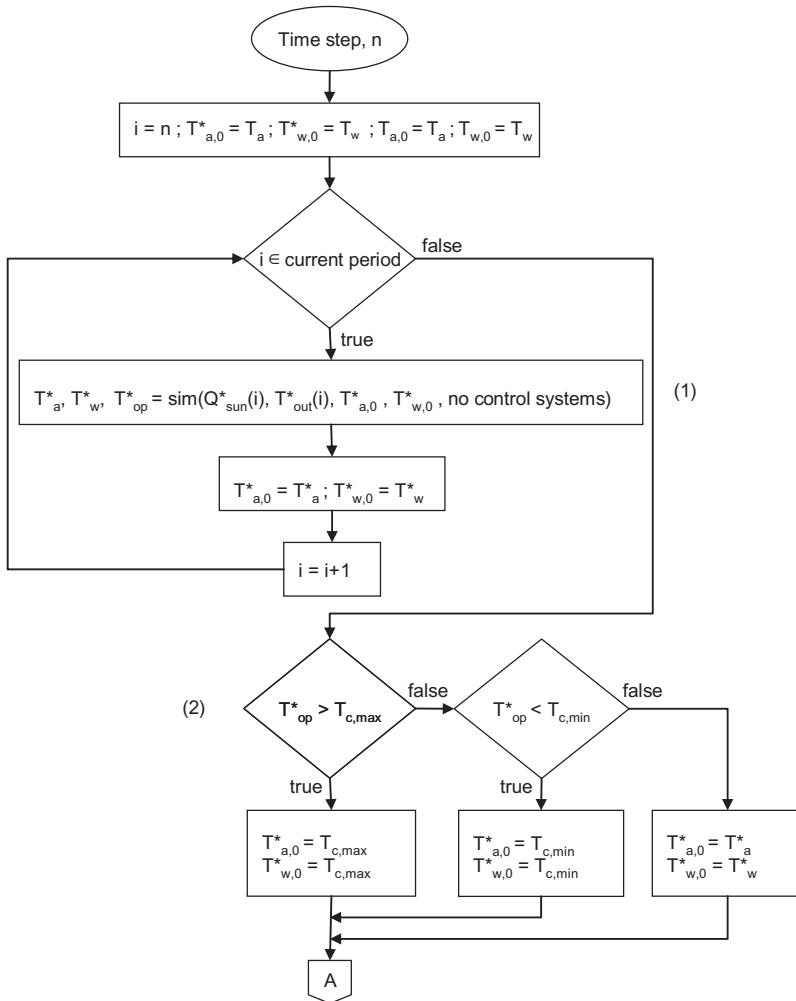

Fig. 1. Flowchart of step 1 of the method. The numbers in brackets refer to detailed descriptions in the main text.

equal to T_a^* and T_w^* from Item (1), but there is a risk that T_a^* and T_w^* lead to a T_{op}^* outside the thermal comfort range, because they are calculated free-floating. It is assumed that the building design and systems are capable of keeping T_{op}^* within the thermal comfort range. So if T_{op}^* from Item (1) is greater than $T_{c,max}$, then $T_{a,0}^*$ and $T_{w,0}^*$ are forced to be equal to $T_{c,max}$. If T_{op}^* is smaller than $T_{c,min}$, then $T_{a,0}^*$ and $T_{w,0}^*$ are forced to be equal to $T_{c,min}$. Otherwise, $T_{a,0}^*$ and $T_{w,0}^*$ are set to T_a^* and T_w^* , respectively. The two first assumptions are in principle non-physical but due to the presence of cooling systems, the reset values are considered to be more realistic than the exceeding values found by the free-floating simulation. The reset also prevents an inexpedient heating or cooling strategy due to an overestimation of the energy need predicted in the following steps of the method. It is furthermore important to note that the assumption is not physically critical since it is an assumption within the prediction algorithm where simulations have no influence on the actual energy balance of the simulation model.

Secondly the cooling set point ($T_{set,cool}^*$) for the current time step n to prevent overheating in the following period is predicted and the cooling strategy needed in time step n to reach $T_{set,cool}^*$ at the end of the current period is established, see Fig. 2.

Fig. 2, Item (3): The maximum operative temperature of the following period, T_{op}^{**} , is calculated free-floating. The hourly weather forecast data for the following period, Q_{sun}^* and T_{out}^{**} , are used as weather data input, and $T_{a,0}^*$ and $T_{w,0}^*$ from Item (2) are used as air and wall temperatures at the beginning of the calculation (time step $n_{start,f}$).

Fig. 2, Item (4): The predicted cooling set point for the time step n , $T_{set,cool}^*$, is determined based the predicted T_{op}^{**} from Item (3) according to the following assumptions:

- There is a heating requirement in the actual period if T_{op}^{**} at the end of the following period is lower than $T_{c,min}$. So $T_{set,cool}^*$ is set to $T_{c,max}$.

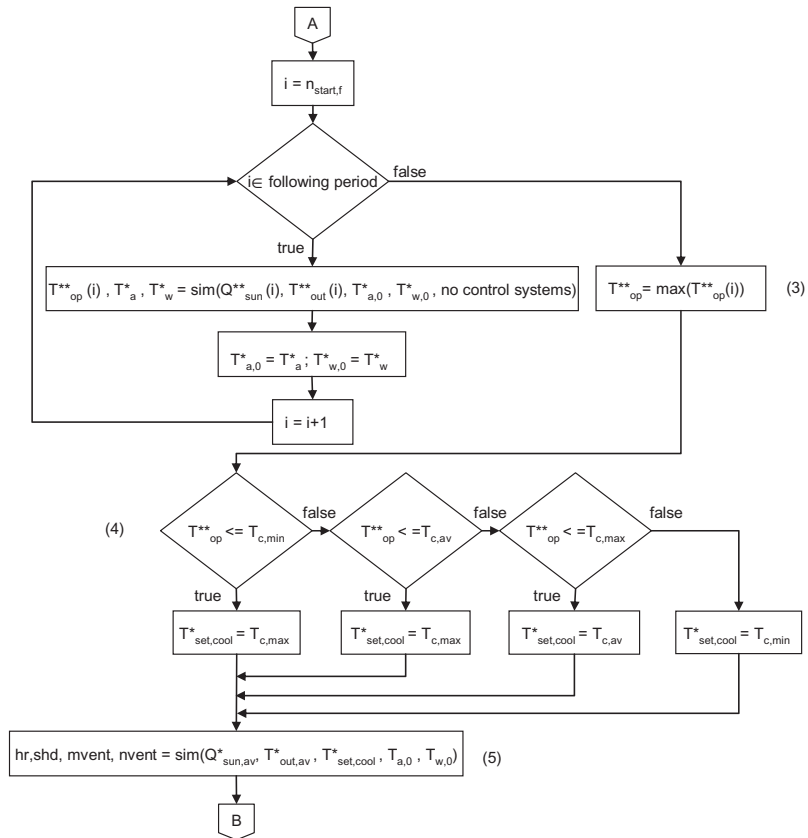

Fig. 2. Flowchart of step 2 of the method. The numbers in brackets refer to detailed descriptions in the main text.

- There is probably a heating requirement rather than a cooling requirement in the actual period if T_{op}^{**} is between $T_{c,min}$ and $T_{c,av}$, where $T_{c,av}$ is $0.5(T_{c,max} + T_{c,min})$. The potential heat gain is fully used to minimise the heating requirement by setting $T_{set,cool}^*$ to $T_{c,max}$.
- There is a predominant need for cooling the building in the actual period to prevent overheating in the following period if T_{op}^{**} is between $T_{c,av}$ and $T_{c,max}$. However, to avoid generating a heating requirement due to excessive cooling, $T_{set,cool}^*$ is set to $T_{c,av}$.
- There is a need for cooling down the building in the actual period to prevent overheating in the following period if T_{op}^{**} at the end of the following period is above $T_{c,max}$. So $T_{set,cool}^*$ is set to $T_{c,min}$. The assumptions above are appropriate for a temperate climate like Denmark's, where free cooling is plentiful compared to solar gains. The assumptions may need to be adjusted for other climates.

Fig. 3, Item (5): A simulation with all user-defined input, the mean value of the forecasted weather data $Q_{sun,av}^*$ and $T_{out,av}^*$ and the predicted cooling set point $T_{set,cool}^*$ from Item (4) is carried out. The purpose is to find out how much of the user-defined control systems is needed, if any, due to $T_{set,cool}^*$. The available systems shown here are the heat recovery rate for mechanical ventilation (hr), external solar shading (shd), increased mechanical ventilation

($mvent$) and/or venting ($nvent$). The rationale for using average weather data for this calculation is to avoid cooling the building too much in time step n . For example, let time step n be an hour in the middle of an out-of-use period and $T_{set,cool}^* = 20$ °C. Using hourly weather data for the calculation, $T_{set,cool}^*$ is reached in time step n by the means of free cooling. This may result in an operative temperature below $T_{set,cool}^*$ in time step $n + 1$, i.e. a heating demand, due to transmission losses. A temperature below $T_{set,cool}^*$ is avoided when using average weather data. Average weather data is only used within the prediction algorithm to establish an appropriate system control strategy and therefore has no effect on the actual energy balance of the building simulation.

2.4.2. Test of predicted system control strategy

This part of the method is testing whether $T_{set,cool}^*$ and the predicted system control strategy are appropriate to maintain the actual operative temperature for time step n , T_{op} , within the thermal comfort range, see Fig. 3. If not, the system control strategy is revised.

Fig. 3, Item (6): If shd , $mvent$ or $nvent$ returned by the simulation in Item (5) in Fig. 2 are not deviating from the user-defined minimum values (meaning that no cooling is needed or that the glare threshold is not exceeded), then the statement "Cooling systems activated" is false. A simulation with the weather data of the current time step n and the user-defined input to the systems is then

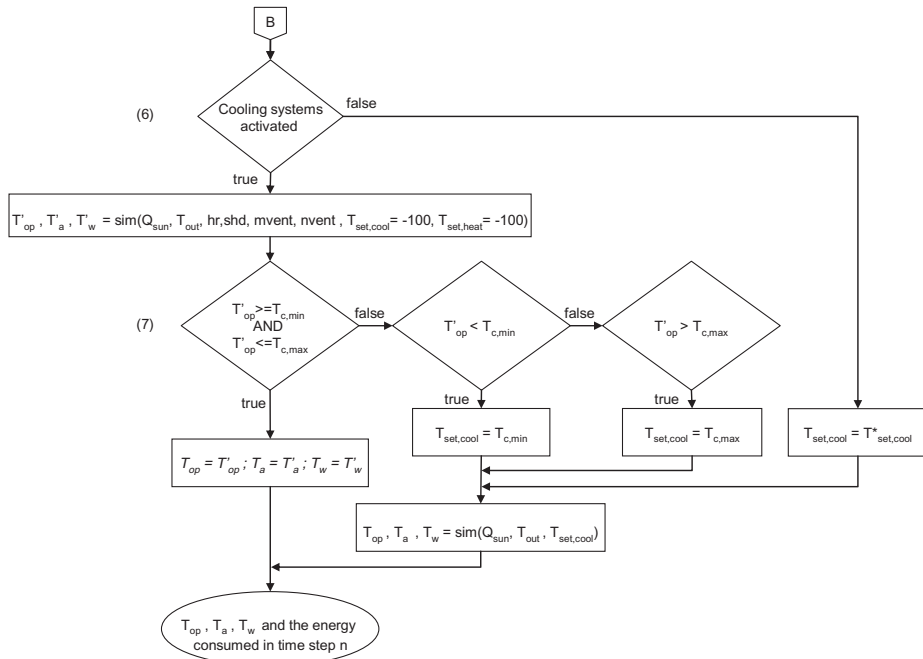

Fig. 3. Flowchart of step 3 of the method: prediction and test of cooling strategy. The strategy is adjusted if it results in a T_{op} outside the thermal comfort range. The numbers in brackets refer to detailed descriptions in the main text.

carried out to find T_{op} . The method then continues to time step $n + 1$. If hr , shd , $mvent$ or $nvent$ are deviating from the user-defined minimum values, then the statement is true. The simulation model is then forced to use the values of hr , shd , $mvent$ and/or $nvent$ ($T_{set,cool}$ set to -100 °C) in a calculation of the operative temperature T'_{op} with the weather data of the current time step, and the heating system turned off ($T_{set,heat}$ set to -100 °C).

Fig. 3, Item (7): The purpose is to test whether the system control strategy, hr , shd , $mvent$ and/or $nvent$ passed on from Item (6), results in a temperature outside the thermal comfort range in the current time step. The test is based on T'_{op} from Item (6). If T'_{op} is within the thermal comfort range, the predicted strategy is accepted, and T_{op} is set to T'_{op} . If T'_{op} is less than $T_{c,min}$, the predicted strategy has resulted in an unacceptable outcome, and the strategy is rejected. A new calculation of T_{op} is performed with $T_{set,cool}$ set to $T_{c,min}$ enabling the simulation model to apply the appropriate strategy to keep T_{op} within the thermal comfort range. If T'_{op} is above $T_{c,max}$ the predicted strategy has also resulted in an unacceptable outcome, and the strategy is rejected in the time step n . A new calculation of T_{op} is performed with $T_{set,cool}$ set to $T_{c,max}$ enabling the simulation model to apply the appropriate strategy to keep T_{op} within the thermal comfort range. After the test, the method continues for time step $n + 1$.

3. Implementation and test

The suggested method was implemented in an existing simplified building simulation tool for integrated daylight and thermal analysis called iDbuild [22]. The tool is mainly chosen because it is considered useful for the early design stages where quick estimates of energy use and thermal indoor environment are needed

for decision support [20]. However, even though it is simplified, the tool gives reliable results compared to detailed tools [23,24]. The tool relies on few inputs to calculate daylight levels, energy demand and the operative temperature in discrete hourly values on a yearly basis based on hourly weather data. Heating, cooling, solar shading, daylight control of lighting, venting, mechanical ventilation with heat recovery and night shutters can be activated by the user to control the operative temperature. The operative temperature is defined in iDbuild as $0.5 \cdot (T_a + T_s)$, where T_a is the air temperature and T_s is considered the area weighted average of the temperatures of all the surfaces in the room. The user alone specifies the available control systems in the specific building design. If there is a cooling requirement the control systems are activated, if made available by the user, in the following predefined order: (1) solar shading, (2) increased venting, (3) increased mechanical ventilation, and (4) mechanical cooling. Furthermore, the user can also specify that the solar shading is activated when a certain glare threshold is exceeded [25].

One of major aims of this paper is to develop a method which facilitates the configuration of the building system control strategy when performing parameter variations in the early stages of building design. An important aspect in this relation is to reduce time for setting up appropriate control schemes for building systems operation in the simulation model. In the current implementation of method the user has to define the settings of the systems available in two periods, namely the in-use and out-of-use period. This is half as many entries compared to setting up a two-season model (four periods: in-use and out-of-use period for two seasons) and 1/4 as many compared to a four-season model (eight periods: in-use and out-of-use period for four seasons).

The following case was used to investigate the impact of the suggested method in terms of energy demand and thermal indoor

Table 1
Data assumptions for test case.

Room dimensions	Height × width × depth	2.8 m × 3 m × 6 m
Window	Height × width	2 m × 2.8 m
	Offset	Symmetrical, 0.8 m from floor
	Glazing type	Double glazing with low-E coating (4–15Ar-SN4)
	Frame	Standard wooden frame, $U = 1.6 \text{ W/m}^2 \text{ K}$, width = 0.08 m, $\psi = 0.05 \text{ W/m K}$
Shading device	External blinds	Activated when the operative temperature exceeds the cooling set point and/or if a glare threshold of 30% is exceeded in the occupied hours. For the two- and four-season model, also when solar radiation on the window exceeds 300 W/m^2 window surface
Constructions	Façade	$U = 0.15 \text{ W/m}^2 \text{ K}$
	Thermal mass	Specific effective heat capacity 432 kJ/K per m^2 floor area
Systems	Infiltration	0.10 l/s m^2 , always active
	Mechanical ventilation in occupied hours	Min. ventilation rate 1.48 l/s m^2 corresponding to class II in EN 15251:2007. Max. ventilation rate is 2.96 l/s m^2 . Average specific fan power of 1.0 kJ/m^3 air. No mechanical cooling available
	Mechanical ventilation in unoccupied hours	Min. ventilation rate is 0.1 l/s m^2 , max. ventilation rate 2.96 l/s m^2 .
	Heat exchanger	Efficiency of 85%
	General lighting	Dimming control, set point 200 lux, min. power 0.5 W/m^2 , max. power 6 W/m^2 , $3 \text{ W/m}^2/100 \text{ lux}$. Only active in occupied hours
	Task lighting	On/off control, set point 500 lux, min. power 0 W/m^2 , max. power 1 W/m^2 . Only available in occupied hours
External conditions	Internal load	300 W in occupied hours, 0 W in unoccupied hours
	Shadows from surroundings	None
	Weather data	Danish design reference year [26]

environment. Assume a single-sided, single-zone two-person office with a south-facing window, located in Copenhagen, Denmark. The occupied period is from 8 a.m. to 4 p.m. every weekday. The lower limit for thermal comfort is set to $20 \text{ }^\circ\text{C}$ and the upper limit is set to $26 \text{ }^\circ\text{C}$. Further data assumptions relevant for the test are shown in Table 1.

The impact of the suggested method was tested by comparing the results with two more conventional rule-based approaches for control of building systems operation:

Two seasons: The year is divided into two periods in accordance with the Danish definition of heating and cooling seasons. The heating season is from the start of October to the end of April and the cooling season is from the start of May to the end of September. Ventilation in unoccupied hours is only available in the cooling season, and the set point for activation is $20 \text{ }^\circ\text{C}$.

Four seasons: The year is divided in four seasons to represent the long transitional periods in the Danish climate. A typical division of the design reference year into four seasons is a heating season from 16 October to 15 April, a transitional period from 16 April to the end of May (spring), a cooling season from June

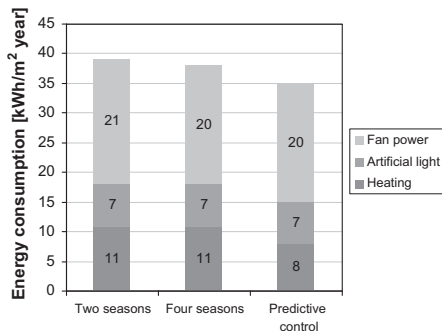

Fig. 4. Annual energy consumption for heating, lighting and fans.

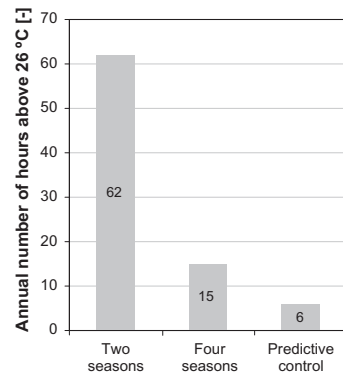

Fig. 5. Overheating in the occupied hours. The recommended criterion for an acceptable number of hours outside the thermal comfort range is 108, according to EN 15251 [21].

to 15th September, and a transitional period from 16 September to 15 October (autumn). Night ventilation is available in the cooling season with a set point of $20 \text{ }^\circ\text{C}$, and in the transitional periods with a set point of $23 \text{ }^\circ\text{C}$.

The results from the test are shown in Figs. 4 and 5. Fig. 4 shows that the number of occupied hours with overheating is lowest for the suggested method. Furthermore, the suggested method prompts an energy consumption which is 7% lower than the four-season model. Finally, it is worth mentioning that the simulation time of the model using the suggested method is 3 min and 39 s which is 13% more than for the two- and four-season model (3 min and 12 s).

4. Discussion of results

The implementation of the method demonstrates that the method needs at least half as many user entries compared to

the seasonal models. This is a facilitation of the task of configuring the control of building systems operation. Furthermore, the implementation does not increase simulation time substantially which is important in relation to make quick estimates of energy use and thermal indoor environment for decision support in the early stages of building design.

The outcome of the test case does not provide enough data to make any solid conclusions regarding the annual performance of the method. The test case, however, indicates that the method's ability to continuously adapt the building systems control has a potential to prompt annual energy savings and improved thermal comfort. This is best illustrated in Fig. 6 where the method demonstrates its ability to predict appropriate cooling set points in a transitional period. In the first half of the plotted period, the weather forecast-based method avoids overheating (temperatures above 26 °C) compared to the seasonal models. The reason is that the method predicts and uses a cooling set point of 20 °C instead of 23 °C or 26 °C in the four-season and two-season model, respectively. In the second half of the plotted period, the method predicts and uses a cooling set point of 23 °C and is thereby, all things being equal, saving energy for mechanical night ventilation compared to the two-season model. Another important aspect of the method's ability to automatically adapt the configuration of the building systems control is that it eliminates time consuming manual configuration of building systems operation when using building simulation for parametric analysis in the early stages of building design.

Another interesting period in relation to the performance of the method is 1 and 2 August, see Fig. 7, since 4 of the 6 h above 26 °C are found in the daytime of these two dates. However, there is no overheating in the two-season and four-season models. The reason is investigated in the following. The predictive control model cools to 23 °C the night before the 31 July whereas the two-season and four-season models cool to 20 °C, see Fig. 7. All three models manage to prevent overheating during the daytime even though different strategies are used. The night before 1 August, all three models try to cool to 20 °C but fail due to relatively high outdoor temperatures. However, the operative temperature in the two-season and

four-season models has a lower point of inflection than the predictive control model. Consequently, only the two-season and four-season models manage to prevent overheating the following day. The reason is that the time constant of the building causes the influence of the cooling accumulated the night before 31 July, i.e. two out-of-use periods ago. In the current case, an increase in exposed thermal mass from 432 to 576 kJ/K per m² floor area eliminates all overheating. In general, a time constant on the order of days may result in control decisions made in a particular period that will have effects not only on the subsequent in-use period, as intended, but on two (or more) subsequent in-use periods. This could result in overheating or, theoretically, a heating demand in the second subsequent in-use period. Building designers should therefore carefully investigate the effect of different combinations of air change rates and amount of accessible thermal mass together with the suggested predictive control method in the early design stages. The overheating 1 and 2 August in the predictive control model in Fig. 7 could probably also have been prevented if the cooling set point the night before the 31 July was predicted to be 20 °C and not 23 °C. To investigate this, the forecast period of the predictive control model is expanded from one out-of-use and in-use period (24 h) to two out-of-use and in-use periods (48 h). This enables the predictive control model to take more advantage of the time constant of the building. Running a simulation with this expansion eliminates all overheating hours in the current case.

As an alternative to the suggested method, an effort could be made to determine more appropriate terminal dates for seasonal control as Fig. 6 shows that the chosen terminal date for the shifts between seasons has a noticeable impact on overheating. One approach to do this is to analyse simulation output. For example, the period before the shift from winter to summer mode in the two-season model in Fig. 6 (8 May) has massive overheating, and there are 3 days in the four-season model (2–3 May) with overheating. More appropriate terminal dates for the seasonal models could be suggested based on this analysis. The new terminal dates could then be tested in a new simulation followed by a new analysis of the simulation output. This process could be repeated until a satisfying performance is reached. This is, however, a time consuming

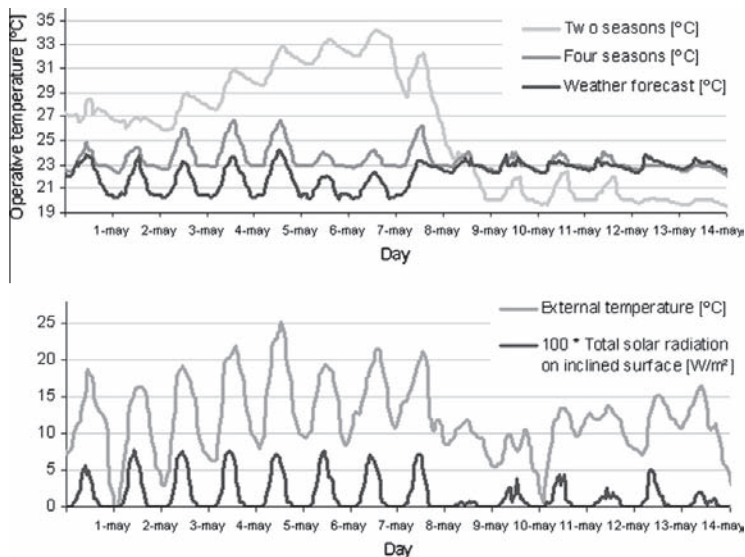

Fig. 6. Transitional period. From 30 April to 14 May, both days included. Terminal date between seasons for the two-season model is 8 May.

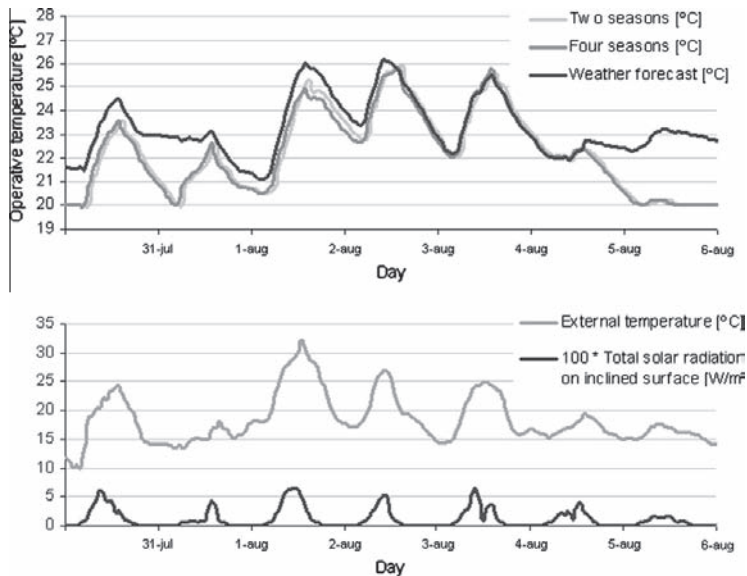

Fig. 7. Summer period. From 30 July to 5 August, both days included.

process which has to be repeated several times when making parametric analysis of energy performance and indoor environment by varying geometry and energy characteristics of building elements and systems. Furthermore, the approach is difficult to relate to actual building operation because actual weather is most likely different from design weather data.

Another approach could be to make an off-line analysis of the design weather data. Provided that this somehow is possible and that the approach can be applied for parametric analysis without a critical increase in time consumption, the approach in relation to actual building operation could be to predict appropriate terminal dates from an off-line analysis of multiple years of historical data. There would, however, be a distinct risk that these predicted terminal dates would deviate from the actual optimal terminal dates of the upcoming year. A more serious defect in this approach is that energy demand in transitional periods may fluctuate between heating and cooling on a daily and not seasonal basis. This defect is avoided in the suggested method for predictive control because it operates with a prediction horizon of one or 2 day. The performance of the suggested method implemented in a real building design would on the other hand rely much on the accuracy of weather forecasts. However, this uncertainty could be acceptable when compared with the uncertainties of the above discussed alternative.

The suggested method currently ignores the effects of humidity. Further work is needed to expand the method to also control night ventilation with respect to humidity. One approach could be to expand the algorithm to make the predictions ensure that the relative humidity is kept within the comfort range according to EN 15251 [21], e.g. 25–60% for a building in category II. Another approach is to relate humidity to the operative temperature in the current algorithm, e.g. by using PMV [27] or the Heat Index [28].

5. Conclusion

A method for simulating predictive control of building systems operation in the early stages of building design was developed. The

method utilises a representation of the building in a building simulation tool and a weather forecast established by looking forward in design weather data to determine whether there is a heating or cooling requirement in a future period. This information is used to determine an appropriate temperature set point and strategy for the control of the building systems in the present time step to prevent operative temperatures outside the comfort range in the future period.

The method can be implemented in an existing building simulation tool with an embedded lighting control which makes control decisions based on an integrated evaluation of lighting and thermal systems. The implementation demonstrates that the method needs at least half as many user entries compared to more conventional control systems, and that simulation time is not increased substantially. A test case featuring an office located in Copenhagen, Denmark was used to analyse the annual performance of the method. At present time there is not enough data to make any solid conclusions regarding the performance of the method. The test case, however, indicates that the method has a potential to reduce the energy demand for heating and ventilation while improving thermal comfort compared to more conventional rule-based control of building systems operation.

The main conclusion in relation to the aim of this paper is that (1) the method facilitate the complex task of setting up appropriate building systems control, (2) the method can automatically adapt the configuration of building systems control when using building simulation for parametric analysis in the early stages of building design, and (3) building designers can predict the annual performance of the suggested method in the early stages of building design without a critical increase in simulation time. There are, however, a number of knowledge gaps which means that the jury is still out on the actual potential and performance of the suggested method. Further work and investigations are therefore needed before the method is implemented in a real building design. A major issue in relation to predictive control in general is the effects of deviations between modelled and actual conditions. The response of the method to uncertainties in weather forecasts should be

examined e.g. by simulating with historical forecasts and corresponding observations instead of design weather data. Deviations between the user pattern of the real building and the user patterns assumed in the simulation model should also be examined. Further work is also required to test the method on other building designs and the applicability of the method for different building scenarios and climates. Finally the current implementation of the method in a simplified simulation tool only applies for preliminary analysis of the effect of the method e.g. in the early stages of building design. The method should therefore be implemented and tested in a sophisticated building simulation tool before applying it in a real building design.

References

- [1] EPBD. Directive 2002/91/EC of the European parliament and of the council of 16 December 2002 on the energy consumption of buildings; 2002.
- [2] Loveday DL, Virk GS. Artificial intelligence for buildings. *Appl Energy* 1992;41:201–21.
- [3] Loveday DL, Craggs C. Stochastic modelling of temperatures for a full-scale occupied building zone subject to natural random influences. *Appl Energy* 1993;45:295–312.
- [4] Huang S, Nelson RM. Rule development and adjustment strategies of a fuzzy logic controller for an HVAC system. *ASHRAE Trans* 1994;100:841–56.
- [5] Liu XF, Dexter A. Fuzzy model-based fault-tolerant control of air-conditioning systems. In: Kakahara, Yoshida, Udagawa, Hensen, editors. *Building simulation '99*, 6th international IBPSA conference, Kyoto; 1999.
- [6] Bhavani RG, Khan MA. An intelligent simulation model for blind position control in daylighting schemes in buildings. *Build Simul* 2009;2:253–62.
- [7] Mistry SI, Nair SS. Nonlinear HVAC computations using neural networks. *ASHRAE Trans* 1993;99:775–84.
- [8] Caudana B, Contin F, Helcke G, Pagani R. A prototype expert system for large-scale energy auditing in buildings. *Pattern Recognit* 1995;28:1467–75.
- [9] Osman A, Mitchell JW, Klein SA. Application of general regression neural network (GRNN) in HVAC process identification and control. *ASHRAE Trans* 1996;102:1147–56.
- [10] Hou Z, Lian Z, Yao Y, Yuan X. Cooling-load prediction by the combination of rough set theory and an artificial neural-network based on data-fusion technique. *Appl Energy* 2006;83:1033–46.
- [11] Underwood CP. Robust control of HVAC plant. Part 1. Modelling. *Build Serv Eng Res Technol* 2000;21:53–61.
- [12] Clarke JA, Cockroft J, Conner S, Hand JW, Kelly NJ, Moore R, et al. Simulation-assisted control in building energy management systems. *Energy Build* 2002;34:933–40.
- [13] Mahdavi A. Simulation-based control of building systems operation. *Build Environ* 2001;36:789–96.
- [14] Mahdavi A. Predictive simulation-based lighting and shading systems control in buildings. *Build Simul* 2008;1:25–35.
- [15] Henze GP, Felsmann C, Knabe G. Evaluation of optimal control for active and passive building thermal storage. *Int J Therm Sci* 2004;43:173–83.
- [16] Henze GP, Le TH, Florita AR, Felsmann C. Sensitivity analysis of optimal building thermal mass control. *J Solar Energy Eng* 2007;129:473–85.
- [17] Wittchen KB, Løgberg E, Pedersen S, Djurtoft R, Thiesen J. Use of weather forecasts to control night cooling. In: Beausoleil-Morrison I, Bernier M, editors. *Building simulation '05*, 9th international IBPSA conference, Montreal; 2005. p. 1347–53.
- [18] Gyalistras D. Use of weather and occupancy forecasts for optimal building climate control (OptiControl). ETH Zurich; 2010.
- [19] Coffey B, Haghighat F, Morofsky E, Kutrowski E. A software framework for model predictive control with GenOpt. *Energy Build* 2010;42:1084–92.
- [20] Petersen S, Svendsen S. Method and simulation program informed decisions in the early stages of building design. *Energy Build* 2010;42:1113–9.
- [21] EN 15251. Indoor environment input parameters for design and assessment of energy performance of building-addressing indoor air quality, thermal environment, lighting and acoustics; 2007.
- [22] idbuild website. <<http://www.idbuild.dk>> [accessed 05.04.11].
- [23] Hviid CA, Nielsen TR, Svendsen S. Simple tool to evaluate the impact of daylight on building energy consumption. *Solar Energy* 2008;82:787–98.
- [24] Nielsen TR. Simple tool to evaluate energy demand and indoor environment in the early stages of building design. *Solar Energy* 2005;78:73–83.
- [25] Wienold J, Christoffersen J. Evaluation methods and development of a new glare prediction model for daylight environments with the use of CCD cameras. *Energy Build* 2006;38:743–57.
- [26] Nilsson P-E. Achieving the desired indoor climate – energy efficiency aspects of system design. Lund, Sweden: Studentlitteratur; 2003.
- [27] Fanger PO. Thermal comfort. New York: McGraw-Hill; 1972.
- [28] Steadman RG. The assessment of sultriness. Part I: A temperature–humidity index based on human physiology and clothing science. *J Appl Meteorol* 1979;18:861–73.

Paper III: Method for component-based economical optimisation for use in design of new low-energy buildings

Published in *Renewable Energy* 38(1) (2012) 173-180



Contents lists available at ScienceDirect

Renewable Energy

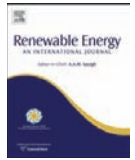
journal homepage: www.elsevier.com/locate/renene

Method for component-based economical optimisation for use in design of new low-energy buildings

Steffen Petersen*, Svend Svendsen

Department of Civil Engineering, Technical university of Denmark, Brovej, Building 118 DK-2800 Kgs. Lyngby, Denmark

ARTICLE INFO

Article history:

Received 25 August 2010

Accepted 16 July 2011

Available online xxx

Keywords:

Energy efficiency

Economic optimization

Cost of conserved energy

Building design

ABSTRACT

Increasing requirements for energy performance in new buildings mean the cost of incorporating energy-saving in buildings is also increasing. Building designers thus need to be aware of the long-term cost-effectiveness of potential energy-conserving measures. This paper presents a simplified and transparent economic optimisation method to find an initial design proposal near the economical optimum. The aim is to provide an expedient starting point for the building design process and more detailed economic optimisation. The method uses the energy frame concept to express the constraints of the optimisation problem, which is then solved by minimising the costs of conserving energy in all the individual energy-saving measures. A case example illustrates how the method enables designers to establish a qualified estimate of an economically optimal solution. Such an estimate gives a good starting point for the iterative design process and a more detailed economic optimisation. Furthermore, the method explicitly illustrates the economic efficiency of the individual building elements and services enabling the identification of potentials for further product development.

© 2011 Elsevier Ltd. All rights reserved.

1. Introduction

The increasing strains on fossil energy resources and increasing awareness of the need to look after the environment is making energy performance an important issue in the design of new buildings. The long-term solution is to eliminate the problems related to the use of fossil fuels by a combination of energy conservation and the use of renewable energy. The economically optimal solution is thus to find the balance between the cost of energy conservation and the cost of renewable energy.

Various types of investment evaluation techniques can be applied for this optimisation. Remer and Nieto [1,2] identified 25 different techniques for project investment evaluation. Among these techniques, net present value (NPV) is the most commonly used for building energy optimisation. The basic rule of NPV is that the option that gives the lowest positive NPV of the total costs is the best option from an economic point of view. NPV has been used for the optimisation of energy-conserving measures in retrofit projects [3,4], and in sophisticated combined life cycle cost and optimisation methods for the design of new buildings [5–7].

Another method for building energy optimisation is a method derived from NPV called the cost of conserved energy (CCE) method

[8]. The unit of CCE is ‘cost per saved energy unit’ which makes it directly comparable with the cost of supplied energy. A measure is considered economically efficient if the CCE is lower than the weighted average cost of primary energy in the useful time of the measure. CCE is a transparent and practicable concept for optimising energy-conserving measures. Currently, the concept has been used to post-assess the economic efficiency of energy-conserving measures in both new and retrofitted buildings based on measured energy savings [9–11], and it has been used to assess and optimise the economic efficiency of potential design decisions in the retrofit of buildings [12,13].

Design of new buildings is an iterative process of exploration, in which the performance of a suggested design proposal fulfilling certain functional traits are predicted and evaluated in a given context [14,15]. If the evaluation shows that the proposed design does not fulfill the performance requirements, either it will be rejected or the designer can try to adjust it. This leads to a ‘design iteration’ where the designer repeats the process of suggesting/adjusting, prediction and evaluation. However, each new iteration means increased time consumption and thus increased building design cost. The task of fulfilling the increasing requirements for energy performance while minimising the cost of incorporating energy-saving may require numerous design iterations especially if the initial design proposal is far from optimum. An initial design proposal near optimum would on the other hand 1) minimise the

* Corresponding author. Tel.: +45 45251928; fax: +45 45931755.
E-mail address: stp@byg.dtu.dk (S. Petersen).

need for design iterations and 2) reduce simulation time of the sophisticated life cycle cost optimisation methods mentioned earlier.

This paper presents a simplified and transparent economic optimisation method to find an initial design proposal near the economical optimum. The aim is to provide an expedient starting point for the building design process and more detailed economic optimisation. The optimisation problem is divided into two levels. At the level of society, the economically optimal balance between the cost of saving energy and the cost of supplying renewable energy is used to set up the requirement for maximum energy use in buildings. The requirement is stated as an energy frame, i.e. the maximum allowed energy use of a building expressed as the sum of energy use per heated m² floor area per year for heating, cooling, ventilation, hot water and lighting (kWh/m² year). The energy frame is a well-known concept for regulating energy efficiency on a societal scale, e.g. in the EU, where national energy requirements are based on the energy frame concept described in the Energy Performance Building Directive (EPBD) [16]. At the level of the building, the optimal solution is found by minimising the total cost of energy-saving measures constrained by the compliance of the energy frame. The method finds this minimum cost where the cost of conserving energy in all the individual energy-saving measures is identical and minimised while fulfilling the energy frame. The output is a qualified estimate of an economically optimal solution, which can be used as a starting point for more detailed economic analysis and iterative design development.

The paper is structured as follows. First we describe the development of a Cost of Conserved Energy model suitable for the design of new buildings and how it can be applied for the economic optimisation of building designs. This is followed by a case example that illustrates the feasibility of the method. Finally, we make concluding remarks and outline suggestions for future research.

2. Method

2.1. Cost of conserved energy for design of new buildings

The basic definition of CCE is according to ref. [8]:

$$CCE = \frac{a(n, d) \cdot I_{\text{measure}}}{\Delta E_{\text{year}}} \quad (1)$$

where, I_{measure} is the investment cost, or additional cost, of an energy-conserving measure (in a monetary unit) and ΔE_{year} is the annual energy conserved by the measure (in a physical unit, e.g. kWh). The factor $a(n, d)$ is the capital recovery rate defined as follows:

$$a(n, d) = \frac{d}{1 - (1 + d)^{-n}} \quad (2)$$

where, d is the real interest rate (in absolute terms) and n is useful life time of the measure (in years). This basic definition of CCE needs a number of supplementing factors if it is to be applicable for the design of new buildings.

2.1.1. Reference period

The useful lifetime of energy-conserving measures may vary from a few years to the entire lifetime of the building. A reference period is therefore introduced to ensure a fair frame of reference for comparison of energy-conserving measures with various useful lifetimes. The useful life time n in equation (2) is replaced by the reference period n_r (in years) and a factor t is introduced:

$$t = \frac{n_r}{n_u} \quad (3)$$

where, n_r is the reference period (in years) and n_u is the useful life time (in years) so that:

$$CCE = \frac{t \cdot a(n_r, d) \cdot I_{\text{measure}}}{\Delta E_{\text{year}}} \quad (4)$$

This modification means that only the fraction of the investment cost equal to the ratio between the reference period and useful life time is depreciated in the reference period. If the reference period is lower than the useful lifetime, a residual value of the energy-conserving measure arises ($(1 - t) \cdot I_{\text{measure}}$). If the reference period is greater than the useful life time, i.e. $t > 1$, a replacement of the energy-conserving measure is needed within the reference period, but only the fraction $(t - 1)$ of the reinvestment cost is depreciated.

The above introduction of a reference period is simplified for $t < 1$, since it only accounts for the investment cost for the fraction r of the investment, while the actual cost is based on the full investment. This is accepted here for the sake of simplicity, but leaves room for improvement. Alternatively, n_u can be set equal to n_r , if full depreciation of an investment with $n_r < n_u$ is desired within the reference period.

2.1.2. Maintenance cost

Some energy-conserving measures require a certain rate of maintenance with an associated cost. The increase in annual maintenance cost, ΔM_{year} , is added to the annualised investment cost I_{measure} as expressed in equation (5).

$$CCE = \frac{t \cdot a(n_r, d) \cdot I_{\text{measure}} + \Delta M_{\text{year}}}{\Delta E_{\text{year}}} \quad (5)$$

If the maintenance cost is expected to occur in an interval smaller or greater than one year, this maintenance cost should be distributed as an annual maintenance cost.

2.1.3. Energy for operation

An energy-conserving measure might consume energy in operation, e.g. a mechanical ventilation unit with heat recovery which saves energy for heating, but uses electricity to do so. This energy consumption $\Delta E_{\text{operation, year}}$ must be subtracted from the energy conserved. If $\Delta E_{\text{operation, year}}$ and/or ΔE_{year} are in units of electricity, they are multiplied by a primary energy conversion factor. The purpose of the primary energy conversion factor is to make heating and electricity delivered to the building comparable. The primary energy conversion factor can be defined in various ways and may take in to account the efficiency of conversion from primary energy to energy delivered to the building, the ratio of renewable energy in the primary energy, and the specific CO₂ emission from different primary energy sources. It is recommend to use locally defined primary energy conversion factors. For example, for a country in the EU the primary energy conversion factor is established as defined in EN 15603 [17]. Some of $\Delta E_{\text{operation, year}}$ might be converted into a heat gain for the building. This gain could be reflected by reducing the primary energy conversion factor. The complete definition of CCE for the suggested method is:

$$CCE = \frac{t \cdot a(n_r, d) \cdot I_{\text{measure}} + \Delta M_{\text{year}}}{f_1 \Delta E_{\text{year}} - f_2 \Delta E_{\text{operation, year}}} \quad (6)$$

where, f_1 and f_2 are the primary energy conversion factors related to the conserved and consumed energy of the energy-conserving measure, respectively.

2.2. Using cost of conserved energy for the economic optimisation of building designs

2.2.1. Criteria for an economic optimum of energy savings versus renewable energy supply

The original formulation of the CCE concept states that a measure is considered economically efficient if the CCE is lower than the price of primary energy from the energy supply system [8]. In other words, the price of primary energy is the constraint in the economical optimisation. Establishing a reasonable price of primary energy for comparison is a difficult task because it relies on assumptions about energy price evolution. Energy price evolution is determined using sophisticated forecasting models [18] [19], which may even take potential phase-out or exhaustion of the conventional energy sources into account [20]. This is an overwhelming task for the ordinary decision maker. Predicting future energy price is a complex task relying on a number of socio-economic assumptions, which makes it more of a societal issue. Instead, we suggest the use of the energy frame concept to state the constraint for economic optimisation.

The energy frame is the minimum requirement for the energy performance of buildings expressed as the energy use per heated m^2 floor area per year for heating, cooling, ventilation, hot water and lighting (kWh/m^2 year). This annual energy use should include auxiliary energy and losses of all systems and is furthermore specific to the particular local climatic conditions. The energy frame is a well-known concept for regulating energy efficiency on societal scale, e.g. in the EU, where national energy requirements are based on energy frames according to the Energy Performance Building Directive (EPBD) [16]. A current revision of EPBD states that all new buildings constructed after 2020 should consume "near zero energy" [21]. The revision defines near-zero-energy buildings as constructions that have "a very high energy performance" with any energy they use coming "to a very large extent" from renewable sources generated "either on-site or nearby". It is therefore an obvious move to make the 2020 energy frame express the socio-economically efficient trade-off between energy conservation and the use of renewable energy.

In this paper, the energy frame concept is considered to be an expression of this trade-off. The energy frame is thus substituting price of primary energy as the constraint in the CCE optimisation.

2.2.2. Relative optimisation of energy-conserving measures

The optimal solution is the combination of energy-saving measures which have the lowest cost while fulfilling the energy constraint (the energy frame). This can be formulated as a constrained optimisation problem. An example featuring two energy-conserving measures gives the following objective function:

$$P = P_1(x_1) + P_2(x_2) \quad (7)$$

where, P is the total cost of two energy-conserving measures (in a monetary unit), $P_1(x_1)$ is the cost of energy-conserving measure 1 as a function of x_1 (in a monetary unit), $P_2(x_2)$ is the cost of energy-conserving measure 2 as a function of x_2 (in a monetary unit), x_1 is the amount of measure 1 (in a quantitative unit) and x_2 is the amount of measure 2 (in a quantitative unit).

It is assumed that the total energy use, E , of the two measures can be calculated as the sum of their individual energy use. We recognise the presence and importance of energy-conserving measure interactions [23], but allow the simplification since the scope is to generate an appropriate starting point for more detailed analysis. The constraint to the objective function is therefore the sum of the energy use of the two elements equal to a specific requirement (the energy frame):

$$E_0 = E_1(x_1) + E_2(x_2) \quad (8)$$

where, E_0 is the maximum allowed energy use, $E_1(x_1)$ is the energy use of measure 1 as a function of x_1 and $E_2(x_2)$ is the energy use of measure 2 as a function of x_2 .

The optimisation problem is thus to find the x_1 and x_2 that give minimum cost and fulfill the constraint of the energy use. As prices increase with x , the minimum total cost is to be found on the line defined by the energy constraint as shown in Fig. 1.

The individual cost functions in equation (7), $P_2(x_2)$ and $P_1(x_1)$, can be expressed as a function of the energy use of the specific energy-conserving measure, $P_1(E_1)$ and $P_2(E_2)$, using the energy constraint in equation (5). The minimum total cost is found on the curve that represents the energy constraint as shown in Fig. 1. The energy constraint in equation (8) states that the sum of the energy use has to be constant. Consequently, a small positive change in E_1 will always have to be equal to a similar small negative change in E_2 when at minimum. Furthermore, the corresponding changes in the cost of the energy-conserving measures, P_1 and P_2 , have to be equal and with opposite signs at the minimum point. This can be expressed as:

$$\frac{dP_1}{dE_1} = -\frac{dP_2}{dE_2} \quad (9)$$

The differential quotient dP/dE is in fact analogous to the definition of CCE. The solution with the lowest cost that fulfils the energy constraint (the optimal solution) can thus be found where the marginal cost of conserved energy of the two measures is identical. The criterion in equation (9) must hold: if e.g. CCE of measure 1 is higher than measure 2 then it would be a more economic efficient solution to have more of measure 2 and less of measure 1. It is noted that the criterion applies for the optimisation of an arbitrary number of energy-conserving measures. Using equation (9) to find the economical optimum is analogue to the notion of economical optimum in fundamental economics where it is commonly recognised that the most effective allocation of resources is to maximise the contribution margin through marginal optimisation [22].

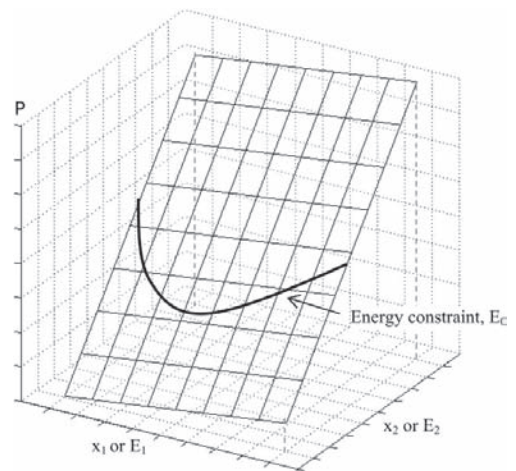

Fig. 1. Illustration of the optimisation problem. As prices P increase with x_1 and x_2 , the minimum cost is to be found on the borderline defined by the energy constraint, $E_0 = E_1 + E_2$.

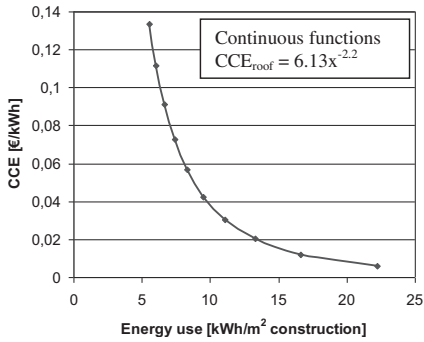

Fig. 2. Example of a continuous function for a continuous measure.

The calculation of marginal CCE for different types of energy-conserving measures enables the direct comparison of their efficiency in a transparent way. CCE can, for example, be used to determine whether it is more efficient to insulate the roof or to

choose a better window component. This is very useful for the building designer in the process of finding the optimal solution.

2.2.3. Optimisation of a building design

The optimisation of a building design using the method suggested is a process of finding the combination of energy-conserving measures where the marginal CCE of the individual measures is identical and at the same time fulfils the energy frame. Continuous functions expressing the marginal CCE of an energy-conserving measure as a function of its energy consumption are applied to facilitate this process. The continuous functions enable the automation of the process of finding the optimal selection of energy-conserving measures for the building design using a numerical solver.

Energy-conserving measures can be divided in two types: measures with continuous energy properties (continuous measures) and measures with discrete energy properties (discrete measures). Optimisation of a continuous measure is a question of optimising quantity, e.g. the amount of insulation material in a construction or the size of a certain window component, whereas optimisation of a discrete measure is about evaluating the quality of the measure, e.g. a window component or a ventilation unit.

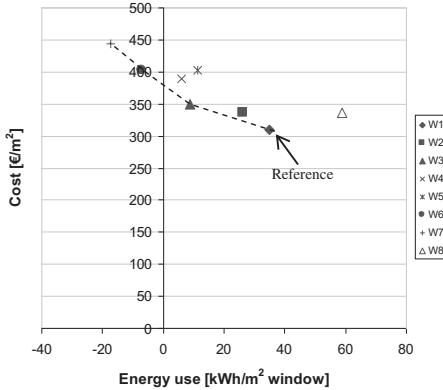

Step 1: Find the first reference.

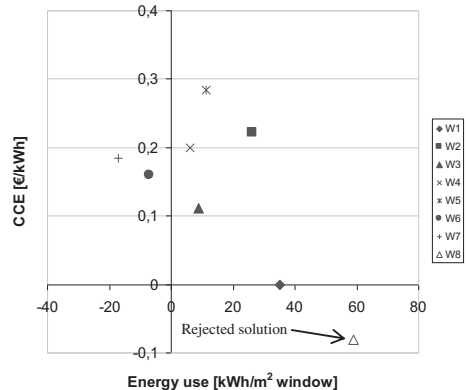

Step 2: Reject solutions with negative CCE

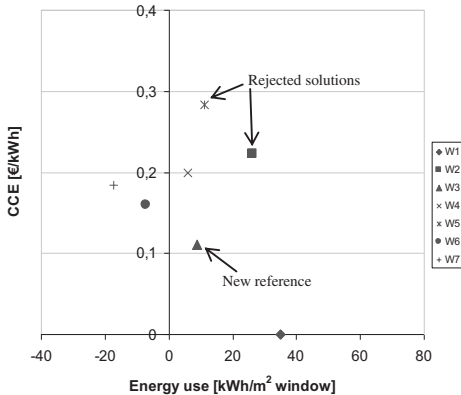

Step 3: Find new reference. Repeat Steps 2 and 3 until there are no components left.

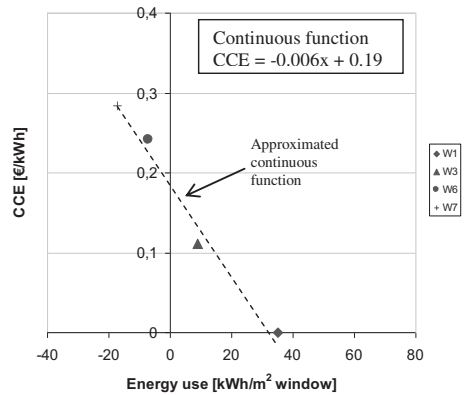

Step 4: Continuous function is generated based on the marginal CCE of the recorded components.

Fig. 3. Illustration of the procedure for establishing a continuous function based on discrete measures.

Establishing a continuous function for a continuous measure is a trivial task: a marginal increase in quantity, e.g. insulation thickness, results in a marginal increase in the CCE and a decrease in energy consumption as shown in Fig. 2.

Generating a continuous function for a discrete measure is more complex. The data of a discrete measure form a discrete function which can be approximated with a continuous function. However, some discrete measures are excluded from the approximation because of their obvious economic inefficiency. Which measures to include in the approximation can be identified visually, as illustrated in Fig. 3 (Step 1), by the dashed line connecting the feasible measures. Automating the generation of a continuous function for a discrete measure, however, requires an analytical approach. A procedure for this is described in the following, using the window component as an example.

- Step 1 The annual energy use of a number of window components is calculated and their cost is listed. The component with the lowest cost is chosen as reference.
- Step 2 The CCE of the remaining components is calculated with respect to the reference. No component with a negative CCE will ever be economically efficient, because they are more expensive than the reference and use more energy, and are rejected.
- Step 3 The window component with the smallest positive CCE is recorded and set as a new reference. All components with an energy use higher than the new reference are not energy-conserving measures and are therefore rejected. Steps 2 and 3 are repeated until there are no components left.
- Step 4 The marginal CCE of the recorded components is calculated starting from the reference found in Step 1. The discrete data sets are then approximated with a continuous function which can be used for treating the discrete measure as a continuous measure in the optimisation of the total building design.

The procedure is illustrated in Fig. 3 using the data in Table 1. The energy use of the windows is calculated using the method for energy-labelling of windows in Denmark [24] as given in equation (10). The method currently only applies for the Danish climate which means that the method should be adjusted or replaced for other climates. The method gives a orientation-weighted net energy gain for windows based on the typical distribution of window area in a Danish building. The intention of the method is to provide an easy way to compare window products. The constants in equation (10) are depend on the climatic data and the reference building used. Therefore other constants must be found for other countries e.g. by using the methodology described in Ref. [24].

$$E = 196.4 g - 90.36 U \tag{10}$$

Table 1
Data assumptions for windows. U-value and g-value are calculated for a window size of 1.23 × 1.48 m.

Windows	U-value W/(m ² K)	g-value	Cost ^a €/m ²	Life time years
W1	1.379	0.456	309	20
W2	1.465	0.540	336	20
W3	1.272	0.540	349	20
W4	0.997	0.428	390	20
W5	0.857	0.337	403	20
W6	0.655	0.337	403	20
W7	0.740	0.428	444	20
W8	1.644	0.456	336	20

^a Prices based on Danish market conditions.

Table 2
Basic assumptions for CCE calculation.

Parameter	
Real interest rate	2.5%
Reference period	30 years
Primary energy factor for electricity	2.5

where, *E* is the net energy gain for the window (kWh/m² window per year), *g* is the total solar energy transmittance of the window and *U* is the total U-value of the window (W/(m²K)). The result is a graph showing that four out of the initial seven components are potential economically efficient solutions (Step 4 in Fig. 3).

To find the optimal solution for the building as a whole, continuous functions for all the main building elements and services are generated as described above. The quantity of each building element and service is then stated, e.g. the area of the constructions and windows, the ventilation rate, etc. The task is then to use the functions to find the optimal distribution of energy-conserving measures for the building design according to the criteria of the suggested optimisation method. The task can be facilitated, for example, by using the numerical solver provided in Microsoft Excel [25]. If the optimised building design contains measures which do not match a known solution (a discrete value), the designer can either search for a solution that matches the optimisation output, or choose the discrete value closest to the optimisation output.

The output is only a qualified estimate of an economically optimal energy solution, since the dynamic behaviour and interactions between energy-conserving measures are not taken into account. The qualified estimate is, however, a good starting point for a process with the purpose of finding the correct optimal solution. One useful tool for this process is iDbuild [15]. iDbuild can be used to perform differential sensitivity analyses of the energy-conserving measures using the qualified estimate as reference. If price functions are added to these analyses, the correct optimal energy solution can be found using the method described. The correct optimal energy solution can then be used as reference when the iterative design process described in Ref. [15] is used to integrate other design issues while fulfilling the energy frame and requirements for the indoor climate.

3. Case example

The following case example illustrates how the method can be applied to establish a good starting point for the iterative design

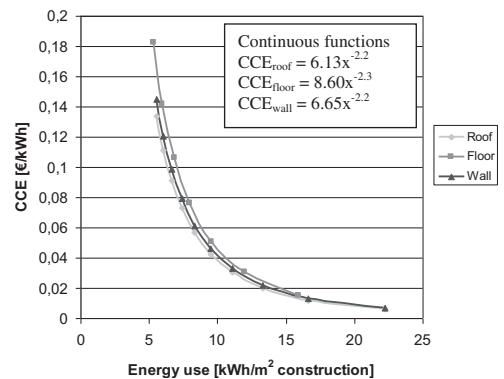

Fig. 4. CCE as a function of energy use for roof, floor and wall.

Table 3
Data assumptions for insulation in wall, roof and floor.

Building Element	Material	Thermal conductivity W/(m K)	Cost €/cm ²	Life time years
Wall	Mineral wool	0.037	1.02	100
Roof	Mineral wool	0.037	0.94	100
Floor	Mineral wool (rigid)	0.038	1.69	100

process and a more detailed economic optimisation. The example used is a two-storey office building. Each floor is 500 m² (16 × 31.25 m) with a floor-to-floor height of 3.5 m. The window area constitutes 43% of the façade. The average mechanical ventilation rate is 1.2 ls⁻¹ m⁻². Mechanical ventilation and lighting are only active on weekdays from 8 am to 5 pm. The building has to be optimised to fulfill an energy frame of 40 kWh/m² year. For the sake of simplicity, the optimisation is limited to the constructions (wall, roof and floor), windows, mechanical ventilation, and lighting. All geometrical parameters, such as window area, are fixed. Furthermore, all maintenance costs are neglected. Table 1 and Table 3–5 contain data for possible energy-conserving measures. All prices are based on Danish market conditions. The individual energy-conserving measures are subject to the analysis described in Section 2.2.3. The basic data needed for calculating the CCE in accordance with equation (6) is given in Table 2.

3.1. Constructions

The energy use per m² wall, roof and floor, Φ_t (kWh/m² construction per year), was calculated with the degree day method [26] as shown in equation (11). Only the thermal resistance of insulation is considered in the example. Thermal resistances of other construction parts and surface resistances are small compared to insulation and are thus ignored to simplify the example.

$$\Phi_t = \frac{\lambda}{d} \cdot D_h \tag{11}$$

where, λ is the thermal conductivity (W/(mK)), d is the thickness (m) and D_h is the number of degree hours in the heating season (kKh). The number of degree hours based on the Danish design reference year [27] equals 90 kKh for wall and roof and 63 kKh for the floor. The heating system is active 24 h a day during the heating season.

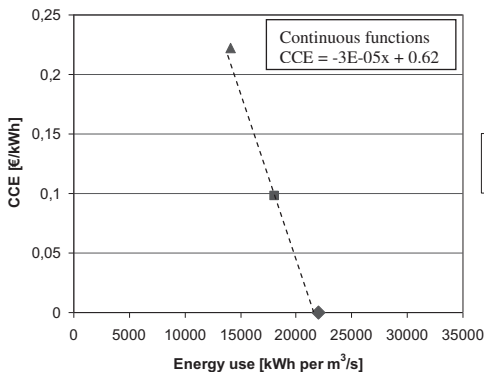

Fig. 5. CCE as a function of energy use for mechanical ventilation.

Table 4
Data assumptions for mechanical ventilation systems.

Mechanical ventilation ^a	Average SFP J/m ³	Heat recovery (type, %)	Cost € per m ³ /s installed	Life time years
V1	1400	Cross, 0.65	62,671	30
V2	1400	Counter, 0.75	70,762	30
V3	1400	Rotary, 0.85	89,109	30

^a The various heat recovery efficiencies affect the pressure loss of the system and thus the average specific fan power (SFP). SFP is however kept constant by sizing other ventilation components (duct system, filters, etc.) correspondingly. The sizing has an effect on the price.

Fig. 4 is a plot of the CCE as a function of energy use calculated with equation (11) and the data in Table 3. The cost is for extra insulation only. More sophisticated cost functions could be applied to represent secondary costs related to increased insulation thickness but these are currently ignored to keep the case example simple. The energy calculations were performed in steps of 0.05 m insulation. The discrete values were approximated with continuous functions.

3.2. Ventilation

The energy use for ventilation, Q (kWh/(m²/s) per year), consists of an electricity consumption and a ventilation heat loss as given by equation (12).

$$Q = SFP \cdot f_e \cdot T + \rho \cdot c \cdot (1 - \eta) \cdot D_v \tag{12}$$

where, SFP is specific fan power (W/(m³/s)), f_e is the primary energy conversion factor for electricity, T is ventilation time in use (kh), ρ is the density of air (kg/m³), c is the specific heat capacity of air (J/kgK), η is the heat recovery efficiency and D_v is the number of degree hours in the heating season for the ventilation (daily use from 8 am to 5 pm = 32.6 kKh, based on the Danish design reference year [27]).

Fig. 5 is a plot of the CCE as a function of energy use calculated with equation (12) and the data in Table 4.

3.3. Lighting

The energy use per m² floor and cost for various lighting systems was provided by the Danish Electricity Saving Trust [28]. The energy use is stated for a lighting level of 200 lux on the working plane. Fig. 6 is a plot of the CCE as a function of energy use

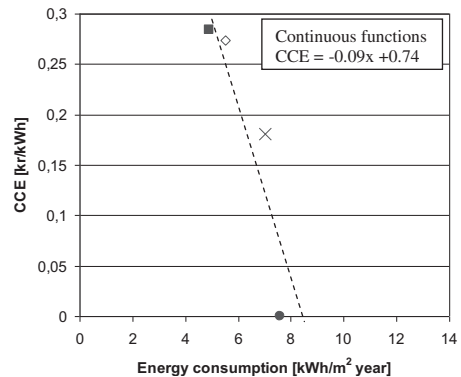

Fig. 6. CCE as a function of energy use for lighting systems.

Table 5
Data assumption for lighting systems.

Lighting	Energy use ^a kWh/m ² year	Cost €/m ² floor	Life time Years
L1	4.9	20.2	15
L2	5.5	18.4	15
L3	7.0	14.2	15
L4	7.2	16.3	15
L5	7.6	13.0	15
L6	8.0	15.8	15
L7	8.3	19.6	15
L8	10.8	20.0	15

^a Primary energy.

for the lighting data in Table 5. The heat gain from lighting may result in a reduction in heating requirement and an increase in cooling requirement. This effect may be significant, especially in office buildings. The effect is, however, ignored here to keep the example simple.

3.4. Optimising the total building design

We used the standard solver in Microsoft Excel [25] to find the optimal distribution of the energy-conserving measures. The target was to reach the energy frame of 40 kWh/m² year by selecting measures subject to the constraint that the CCE is equal for all measures. Furthermore, the optimisation of insulation level in wall, roof and floor was constrained to a maximum thickness of 0.3, 0.5 and 0.4 m, respectively. Optimising without such constraints could result in excessive levels of insulation since the CCE for insulation in wall, roof and floor is significantly lower than for windows and services. The optimisation result is shown in Fig. 7.

The solution does not fulfill the constraint that the CCE for all measures should be equal because of the insulation thickness constraints for wall and roof. The optimised energy use for the floor is 3.1 kWh/m² year which corresponds to 0.39 m insulation, i.e. practically the maximum thickness of 0.4 m. The optimised energy use for ventilation is between ventilation system V2 and V3 in Fig. 5 and a window component and lighting system that fulfils the optimised energy use can also be found between two discrete measures in Fig. 3 (Step 4) and Fig. 6, respectively. The final solution must however consist of available elements and services. Ventilation system V2 (21.7 kWh/m² year), window component W3 (4.9 kWh/m² year) and lighting system L3 (7.0 kWh/m² year) are closest to their optimised energy use. Together with the energy use of the constructions shown in Fig. 7, the total for the solution is

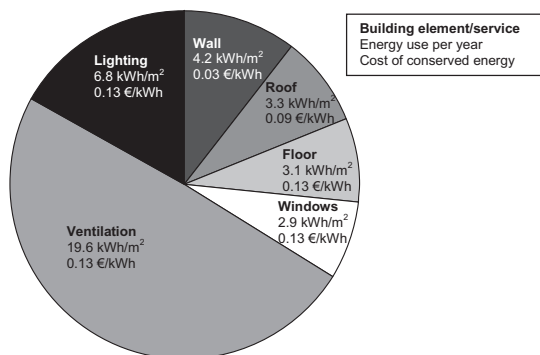

Fig. 7. The distribution of the energy uses in the economically optimal solution for the case example.

44.2 kWh/m² per year. This means that more energy-conserving measures have to be chosen to fulfill the energy frame of 40 kWh/m² year. The ventilation system V3 has a CCE of 0.22 €/kWh and is the cheapest measure compared to the next lighting system L2 (CCE of 0.27 €/kWh), and the next window system W6 (CCE of 0.24 €/kWh). The total for the solution with V3 instead of V2 is 39.5 kWh/m² per year. This combination brings the building design close to the energy frame and the optimised energy use of the individual building elements/services. The combination is therefore considered a good starting point for the process of finding the correct optimal solution for the case example. Furthermore, Fig. 7 shows that energy use for ventilation constitutes 49% of the total energy use. This indicates a potential for economically efficient energy savings in the development of more energy efficient ventilation systems.

4. Conclusion

We have presented a simplified and transparent method which integrate economic optimisation into the design decisions made in the early stages of design. We have given proof that an economic optimum can be found where the marginal cost of conserved energy is identical for all energy-conserving measures and the building using the energy-conserving measures also fulfils a certain energy demand. The energy demand is suggested to be set as the socio-economic trade-off between energy savings and use expressed as an energy frame. The method is thus to use the marginal cost of conserved energy to identify the economically optimised combination of various energy-conserving measures needed to fulfill the energy frame. A case example featuring the optimisation of a two-storey 1.000 m² office building is given to illustrate the feasibility of the method. The example illustrates how the method is able to generate a qualified estimate of an economically optimal solution which can be used as starting point for detailed optimisation and iterative design. Further work is required to include geometrical parameters, such as window area, and other energy-related issues such as the efficiency of heating and cooling systems, infiltration, and the effect of heat gains from people, equipment and lighting in the generation of the qualified estimate.

In conclusion, the potential benefits from using the method is that it 1) introduces economic optimisation in the early stages of the building design process which is of increasing interest due to low-energy requirements, and 2) explicitly illustrate the economic efficiency of the individual building elements and services enabling the identification of potentials for further product development.

References

- [1] Remer DS, Nieto AP. A compendium and comparison of 25 project evaluation techniques: Part 1. Net present value and rate of return methods. *International Journal of Production Economics* 1995;42:79–96.
- [2] Remer DS, Nieto AP. A compendium and comparison of 25 project evaluation techniques: Part 2. Ratio, payback, and accounting methods. *International Journal of Production Economics* 1995;42:101–29.
- [3] Verbeeck G, Hens H. Energy savings in retrofitted dwellings: economically viable? *Energy and Buildings* 2005;37(7):747–54.
- [4] Gustafsson S-L. Optimisation of insulation measures on existing buildings. *Energy and Buildings* 2000;33(1):49–55.
- [5] Nielsen TR. Optimization of buildings with respect to energy and indoor environment. PhD Dissertation, Technical University of Denmark, 2002.
- [6] Pedersen F. A method for optimizing the performance of buildings, PhD Dissertation, Technical University of Denmark, 2007.
- [7] Verbeeck G, Hens H. Life cycle optimization of extremely low energy dwellings. *Journal of Building Physics* 2007;31(2):143–77.
- [8] Meier A. What is the cost to you of conserved energy?. *Harvard Business Review*; January-February 1983.
- [9] Cohen S, Goldman CA, Harris J. Energy savings and economics of retrofitting single-family buildings. *Energy and Buildings* 1991;17(4):297–311.

- [10] Wall LW, Goldman CA, Rosenfeld AH, Dutt GS. Building energy use compilation and analysis (BECA) Part B: retrofit of existing north American residential buildings. *Energy and Buildings* 1983;5(3):151–70.
- [11] Piette MA, Nordman B, De Buen O, Diamond R. Findings from a low-energy, new commercial buildings research and demonstration project. *Energy* 1995;20(6):471–82.
- [12] Martinaitis V, Rogo, a A, Bikmanien&sedot I. Criterion to evaluate the "twofold benefit" of the renovation of buildings and their elements. *Energy and Buildings* 2004;36(1):3–8.
- [13] Gieseler UD, Heidt FD, Bier W. Evaluation of the cost efficiency of an energy efficient building. *Renewable Energy* 2004;29(3):369–76.
- [14] Kalay YE. Performance-based design. *Automation in Construction* 1999;8(4):395–409.
- [15] Petersen S, Svendsen S. Method and simulation program informed decisions in the early stages of building design. *Energy and Buildings* 2010;42(7):1113–9.
- [16] Directive 2002/91/EC of the European parliament and of the council of 16 December 2002 on the energy consumption of buildings; 2002.
- [17] EN 15603. Energy performance of buildings – Overall energy use and definition of energy ratings; 2008.
- [18] Pindyck RS. The long-run evolution of energy prices. *The Energy Journal* 1999;20(2):1–27.
- [19] Prospective outlook on long-term energy systems (POLES), http://www.enerdata.fr/enerdatauk/tools/Model_POLES.html.
- [20] Fisk DJ. The economic value of conserving energy. *Journal of the Institute of Fuel* 1979;51(409):187–90.
- [21] European Commission webpage, http://ec.europa.eu/energy/efficiency/buildings/buildings_en.htm.
- [22] Friedman M. *Price theory*. New York: Aldine publishing Company; 1976.
- [23] Crown SW, Pate MB, Shapiro HN. A method to account for energy conservation measure interactions. *ASHRAE Transactions: Research* 1993;99:201–6.
- [24] Duer K, Svendsen S, Mogensen MM, Laustsen JB. Energy labelling of glazings and windows in Denmark: calculated and measured values. *Solar Energy* 2002;73(1):23–31.
- [25] Excel (Part of Microsoft Office Professional Edition). Microsoft; 2003.
- [26] ASHRAE. 2005 ASHRAE Handbook Fundamentals, Atlanta; 2005. 32.18.
- [27] Jensen JM, Lund H. Design reference year – a new Danish reference year (in Danish), Technical University of Denmark, LFV announcement no. 281; 1995.
- [28] Danish Electricity Saving Trust, <http://application.sparel.dk/asp/belysning/liste.asp?positivstrtype=kontor> [in Danish].

Report I: The basis for annual, hourly lighting simulations based on bi-directional transmittance distribution functions in iDbuild

Adding complex fenestrations to the solution space

A reoccurring issue in relation to building simulation is the desire to be able to evaluate the performance of complex fenestration systems (CFS). This report describes a method for predicting the daylight performance of CFS such as daylight redirecting devices, novel solar blinds and advanced glazing materials.

1 Introduction

In relation to the method and tool described in [1], the desire for CFS as a part of the solution space provides the ability to make fast integrated performance predictions in the conceptual design phase. The iDbuild simulation tool developed for this. The simplified calculation routines of the tool are representing the opaque part of the façade with a U-value, and the transparent part with uni-directional, profile angle dependent U-values, solar transmittances and light transmittances generated in the WIS program [2][3]. The investigations provided by Hviid et. al. in ref. [4] shows that the use of WIS data as input to the simple, rapid daylight algorithm of iDbuild is sufficiently accurate to represent the distribution of incoming daylight through simple fenestration materials like clear, tinted, or reflective glass. Representing the properties of optically more complex fenestration materials like venetian blinds with uni-directional data is however the reason for relative errors up to 35% compared to Radiance calculations for a glazing/blind system. This may be sufficiently accurate taking in to consideration the importance of simulation speed and ease of use in the conceptual design phase, but there is room for improvements. More important to the suggested design method and the conceptual design phase is that the number of solar shading solutions available in the WIS database is very limited. Furthermore, is not possible to model and represent innovative fenestrations, e.g. redirecting devices, novel solar blinds and advanced glazing materials.

Instead of WIS data, the photometric properties of CFS could be characterised more accurate and objective by a bidirectional transmission distribution function (BTDF) [5] [6]. BTDF express the emerging light distribution for a given incident direction [7]. The unit for BTDF is the luminance of transmitted light flux (cd m^{-2}) per illuminance of the fenestration material due to the incoming light flux (lux). BTDF of a CFS can be determined by measurement, using integrating spheres [8] or by calculations based on a numerical goniophotometer [9] [10].

The practical application of BTDF in building simulation is currently limited. Reinhart and Andersen [11] used gonio-photometer and integrated sphere measured BTDF in Radiance with the Perez sky model [19] and a daylight coefficient approach [12] to model the daylight performance of a translucent panel. De Boer has developed a methodology for including BTDF into daylight simulations which was implemented and tested in Radiance [13]. Currently, the only integrated

daylight and thermal performance prediction based on BTDF is in EnergyPlus [14] through Delight [15]. This implementation is mainly relevant for detailed design investigations than for investigations in the conceptual design phase. An implementation of BTDF in the integrated daylight and thermal performance predictions of a simple simulation tool like iDbuild would however enable designers to add more complex fenestrations to the solution space in the conceptual design phase.

2 Calculating the daylight performance of complex fenestration systems

This section describes a daylight calculation method for determination of room illumination by fenestrations with a luminous intensity distribution represented by bidirectional photometric data. The main idea is relatively simple:

1. The BTDF data is transformed into bidirectional transmission coefficients (BTC).
2. The current algorithm of LightCalc interpolates a transmittance for each sky and ground patch from uni-directional WIS data. Instead a value from BTC data is interpolated and the current algorithm of LightCalc is continued.

Details on the method are given in the following sections.

2.1 Transforming of BTDF data into bidirectional transmission coefficients

The procedure to transform BTDF data into bidirectional transmission coefficients is given in the following. The procedure is derived from Kim et. al [16] and Kaempf and Scartezzini [17]. It is provided that the experimental monitoring procedure of BTDF follows the discretation of the Tregenza scheme, see appendix 1, meaning that a full BTDF data set of a CFS is a 145x145 matrix (145 outgoing directions for each of the 145 incoming direction). Consequently, each component of the BTDF data can be associated to a well defined hemispherical sector. As each BTDF component is constant over these sectors, the transmission coefficient over the hemispherical sector can be determined by means of the following simple product:

$$\tau(\theta_i, \varphi_i, \theta_t, \varphi_t) = BTDF(\theta_i, \varphi_i, \theta_t, \varphi_t) \cdot \cos(\theta_i) \cdot d\omega_t \quad (1)$$

where

$\tau(\theta_i, \varphi_i, \theta_t, \varphi_t)$ is the transmission coefficient for incoming direction (θ_i, φ_i) and outgoing direction (θ_t, φ_t) .

$BTDF(\theta_i, \varphi_i, \theta_t, \varphi_t)$ is the BTDF for the incoming direction (θ_i, φ_i) and outgoing direction (θ_t, φ_t) .

θ_i is the altitude of the incoming direction.

$d\omega_t$ is the solid angle subtended by the exterior hemisphere (sky or ground) element.

Since there are 145 outgoing directions for each of the 145 incoming direction, a summation over the whole hemisphere, $d\omega_h$, is necessary to get the directional-hemispherical transmission coefficient:

$$\tau_h(\theta_i, \varphi_i) = \sum_{d\omega_i \in d\omega_h} BTDF(\theta_i, \varphi_i, \theta_t, \varphi_t) \cdot \cos(\theta_i) \cdot d\omega_i \quad (2)$$

A BTC thus consists of 145 transmission coefficients arranged according to the Tregenza scheme.

2.1.1 Direct generation of bidirectional transmission coefficients

Bidirectional transmission coefficients (BTC) arranged according to the discretisation scheme proposed by Tregenza [21], see appendix 1, can be generated directly using the Opticad-based BTDF/BTC generator developed by Moeller [18]. Two Tregenza coordinate schemes are merged around the fenestration, see figure 1, generating a set of BTC arranged in the Tregenza scheme for each of the 145 incident directions. This means that the incoming light flux is entering the fenestration on the backside of the outgoing Tregenza scheme.

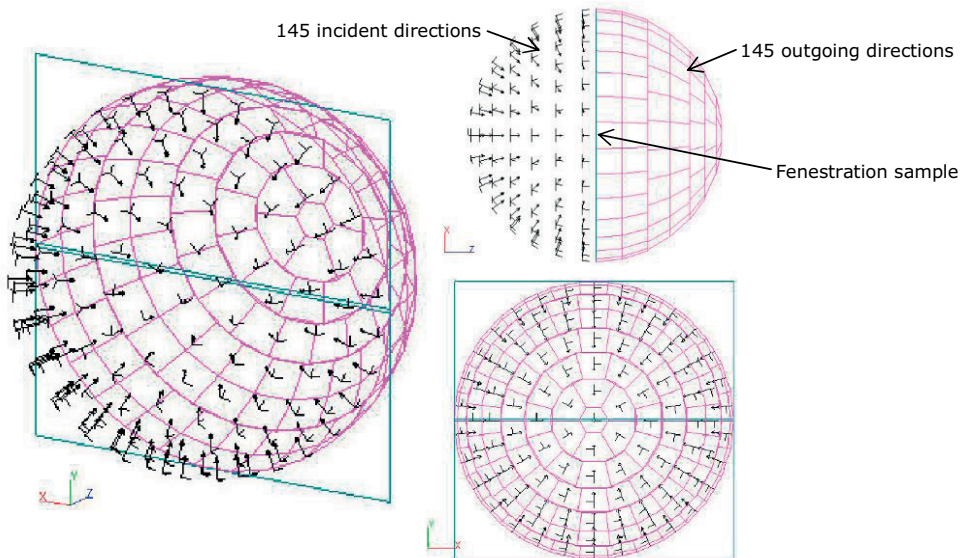

Figure 1. The BTDF/BTC sampling set up in OptiCad, to the left 3D and to the right 2D.

The data is arranged in a 145x145 matrix with incoming directions in the i th direction and the appurtenant 145 outgoing BTDF/BTC in the j th direction. Both directions are following the numbering in the Tregenza scheme, e.g. position (45,87) contains the BTDF/BTC for the outgoing direction of patch 87 for the incident direction of patch 45.

2.2 Interpolating transmittances from BTC data

2.2.1 Representing external daylight condition

The model for external daylight conditions for LightCalc [4] uses an upper sky dome for atmospheric light and a lower (inverted) sky dome for ground reflections (one above and one below the horizontal plane) to model the external light conditions. The domes are divided into 145 patches using a discretisation scheme proposed by Tregenza, see appendix 1. Since each patch subtends a similar solid angle Φ (Sr), every patch can be treated as a point source with insignificant error. Each point has patch identification number and a certain set of spherical coordinates (r, θ, ϕ) representing an incident direction to the fenestration system.

The luminance of each sky point can be calculated using a number of different sky models. E.g. the 10K CIE overcast sky can be applied for calculating daylight factors, and the Perez all-weather model can be used for modelling anisotropic sky radiation [19]. The ground is represented as a luminous up-side down sky with constant brightness. The ground luminance is the mean ground reflectance (albedo) multiplied with the total sky illuminance.

2.2.2 Transforming sky coordinates to BTC coordinates

A spherical coordinate of a the sky or ground vault (r, θ_n, ϕ_n) intersects the BTDF/BTC tregenza scheme in the coordinate (r, θ_p, ϕ_p) . However, the pole of the coordinate (r, θ_n, ϕ_n) is the centre of the horizontal disc whereas the pole for (r, θ_p, ϕ_p) is the centre of the BTC. To find (r, θ_p, ϕ_p) the incoming coordinate (r, θ_n, ϕ_n) therefore has to be converted to the coordinate system of the BTC coordinate before an interpolation of BTC can be performed.

First, the spherical coordinates of a the sky or ground vault (r, θ_n, ϕ_n) are converted to Cartesian (rectangular) coordinates. When a point in a three dimensional coordinate system is given in spherical coordinates, its corresponding Cartesian coordinates, (x_n, y_n, z_n) can be found with the following mathematical rules (NOTE: Matlab has an imbedded function $[x, y, z] = \text{sph2cart}(\text{THETA}, \text{PHI}, R)$ for this conversion.):

$$x = r \cos \theta_n \cos \phi_n$$

$$y = r \cos \theta_n \sin \phi_n$$

$$z = r \sin \theta_n$$

$$\text{when } r \in [0, \infty[, \theta \in [0, \pi] \text{ and } \phi \in [0, 2\pi[$$

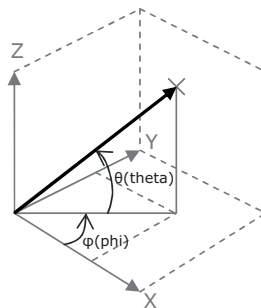

The rectangular coordinates (x_n, y_n, z_n) are then changing basis according to the notation in figure 2.

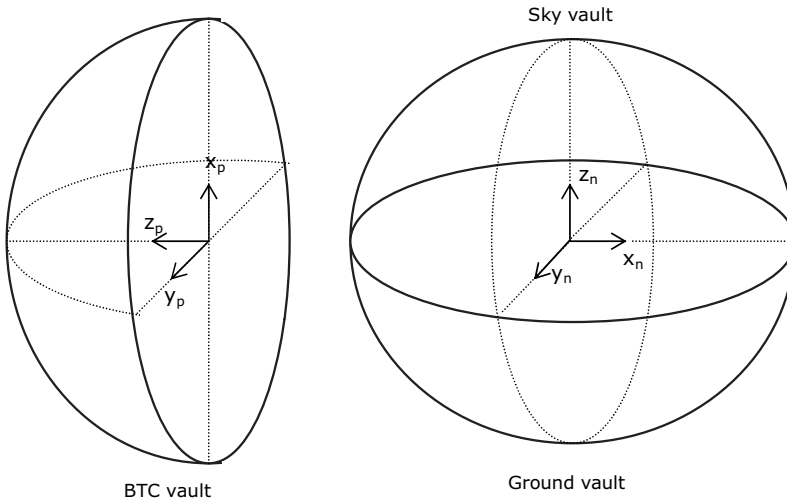

Figure 2. Basis for the sky/ground vault coordinates (r, θ_n, ϕ_n) and the BTC coordinates (r, θ_p, ϕ_p) .

The coordinate (x_n, y_n, z_n) for the sky/ground coordinate n is changing basis to (x_p, y_p, z_p) . The matrix to the left is thus a transformation matrix for (x_n, y_n, z_n) to (x_p, y_p, z_p) :

$$\text{Transformation matrix} \begin{bmatrix} 0 & 0 & 1 \\ 0 & 1 & 0 \\ -1 & 0 & 0 \end{bmatrix} \begin{bmatrix} x_n \\ y_n \\ z_n \end{bmatrix} = \begin{bmatrix} x_p \\ y_p \\ z_p \end{bmatrix}$$

The Cartesian coordinates (x_p, y_p, z_p) is converted back to spherical coordinates (NOTE: Matlab has an imbedded function $[\text{THETA}, \text{PHI}, \text{R}] = \text{cart2sph}(X, Y, Z)$ for this conversion):

$$\theta_p = \tan^{-1} \left(\frac{z_p}{\sqrt{x_p^2 + y_p^2}} \right)$$

$$\phi_p = \tan^{-1} \left(\frac{y_p}{x_p} \right)$$

2.2.3 Interpolating transmittances for each sky and ground coordinate

The transformed spherical coordinate of the n th sky/ground patch (r, θ_p, ϕ_p) is not likely to be the same as for the centroid of a BTC Trengenza patch. Instead, (r, θ_p, ϕ_p) may have up to four appurtenant BTC Trengenza patches. Figure 3 illustrates the three ways that (r, θ_p, ϕ_p) may intersect the BTC Trengenza scheme.

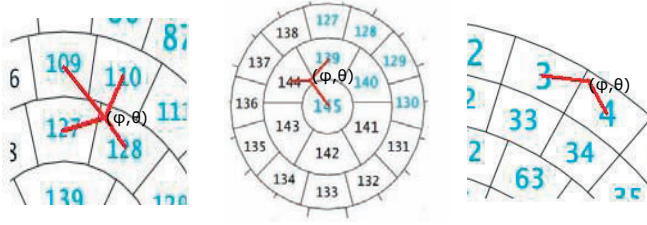

Figure 3: The three ways (r, θ_n, ϕ_n) may intersect the Tregenza scheme of the BTC.

In all three situations, we need to create a new BTC for (r, θ_p, ϕ_p) . In order to do so, an angular interpolation procedure suggested by Reinhart [20] is adopted. The procedure is developed for modification of BTDF data by means of weighting factors that depend on the angular distances in-between a given incidence direction and the centroids of neighbouring sectors. Knowing the incident direction, in this case (r, θ_p, ϕ_p) , the orthodromic distance (the length of the spherical segments between a pair of points located on a hemisphere) between the incident direction and the surrounding centroids can be calculated. Kaempf and Scartezzini [17] used the same procedure to improve the representation of the direct daylight component in their scene rendering using BTDF, and derives the formula for the orthodromic distance, ψ , between two points expressed in spherical coordinates, e.g. (θ_i, ϕ_i) and (θ_p, ϕ_p) , as follows:

$$\cos\psi = \sin\theta_i \cdot \sin\theta_p \cdot \cos(\phi_i - \phi_p) + \cos\theta_i \cdot \cos\theta_p \quad (3)$$

where

ψ is measured in radians.

Let the coordinate (θ_p, ϕ_p) in formula (3) be the transformed spherical coordinate of an incident coordinate (θ_n, ϕ_n) , and let it have four neighbouring centroid (θ_i, ϕ_i) (Figure 3, left). The BTC for (θ_p, ϕ_p) can then be calculated as:

$$BTC_p = \sum_{i=1}^4 \omega_i BTC_i \quad , \quad \omega_i = \frac{1}{\psi_i} = \frac{1}{\sum_{i=1}^4 \frac{1}{\psi_i} \cdot \psi_i \sum_{i=1}^4 \frac{1}{\psi_i}} \quad (4)$$

where ω_i is the weighing factor belonging to the BTC for Tregenza coordinate i , BTC_i . ψ_i is the orthodromic distance between the incident direction (θ_p, ϕ_p) and a neighbouring Tregenza coordinate (see formula (3)), where the index i refers to the patch id of the neighbouring Tregenza coordinate. Note that ψ_i in the weighing factor ω_i is inverted because the shortest distance to the incident direction should have the highest weight. The BTC of the transformed sky/ground coordinate (θ_p, ϕ_p) is thus a distance-weighted fraction of the neighbouring BTC Tregenza patch centroids.

3 Integration into daylight simulation tool

The described method is implemented in the lighting simulation program LightCalc [4]. The implementation is not fully validated due to the deadline of this thesis. However, a minor validation has been made to test whether the implementation provides similar results as the current uni-directional approach in LightCalc. A BTC data set for a 2-layer glazing is generated using the Opticad-based BTDF/BTC generator developed by Moeller [18]. A corresponding data set is generated with WIS. Both data sets are found in Table 1. The two data sets are used to represent the fenestration in a test room which dimensions are specified in Figure 4. Other data assumptions for the test case are found in Table 2. The results of the simulations are shown in figure 6. The results are quite similar as expected: the transmittance data is almost the same. The BTC result in the point $(x,y,z) = (2,5.5,0.85)$ is, however, 7 lux higher compared to the WIS result corresponding to 2.7%.

Table 1. Transmittance data from OptiCad and WIS.

Tregenza band no.	Incident angle [°]	Transmittance WIS [-]	Transmittance OptiCad [-]	Difference [%]
1	84	0.135	0.138	2.2
2	72	0.451	0.460	2.1
3	60	0.671	0.668	0.4
4	48	0.760	0.761	0.2
5	36	0.796	0.795	0.1
6	24	0.807	0.806	0.1
7	12	0.810	0.809	0.1
8	0	0.811	0.809	0.2

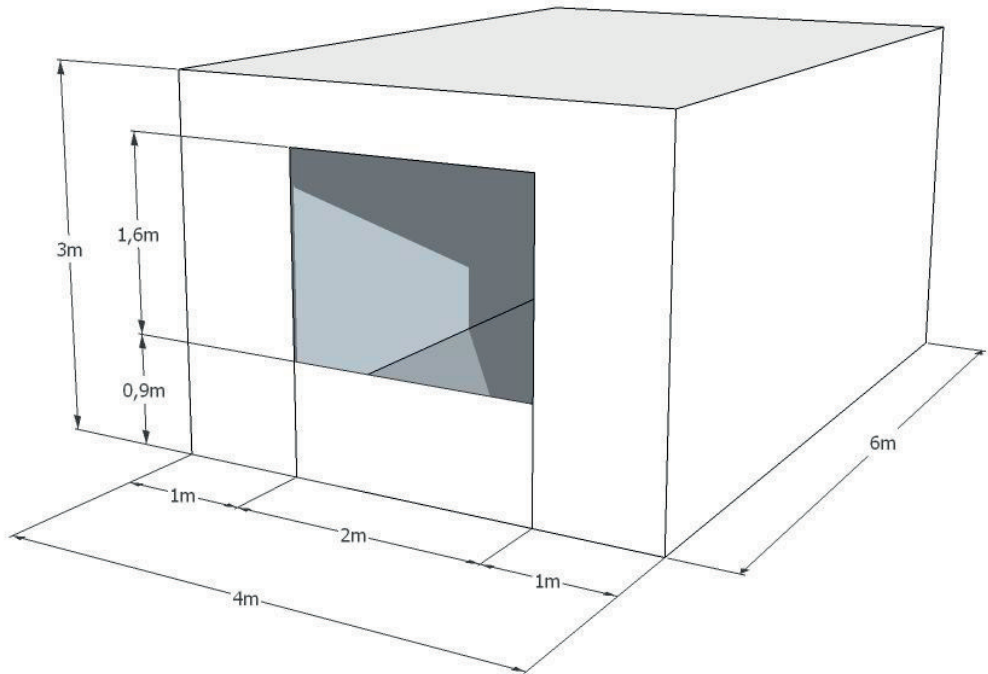

Figure 4. Dimensions of the validated room.

Table 2. Data assumptions for test case.

Room dimensions	Height × width × depth	3 m × 4 m × 6 m
Window	Height × width	1.6 m × 2 m
	Offset	Symmetrical, 0.9 m from floor.
	Glazing type	2-layers of clear glazing ($Lt_{\perp} = 0.81$)
Diffuse reflectance	Wall	0.70
	Floor	0.30
	Ceiling	0.80
	Glazing	0.215
	Albedo	0.20
Calculation settings	Subsurface size	0.5 m × 0.5 m
Sky model	10K CIE standard overcast sky	

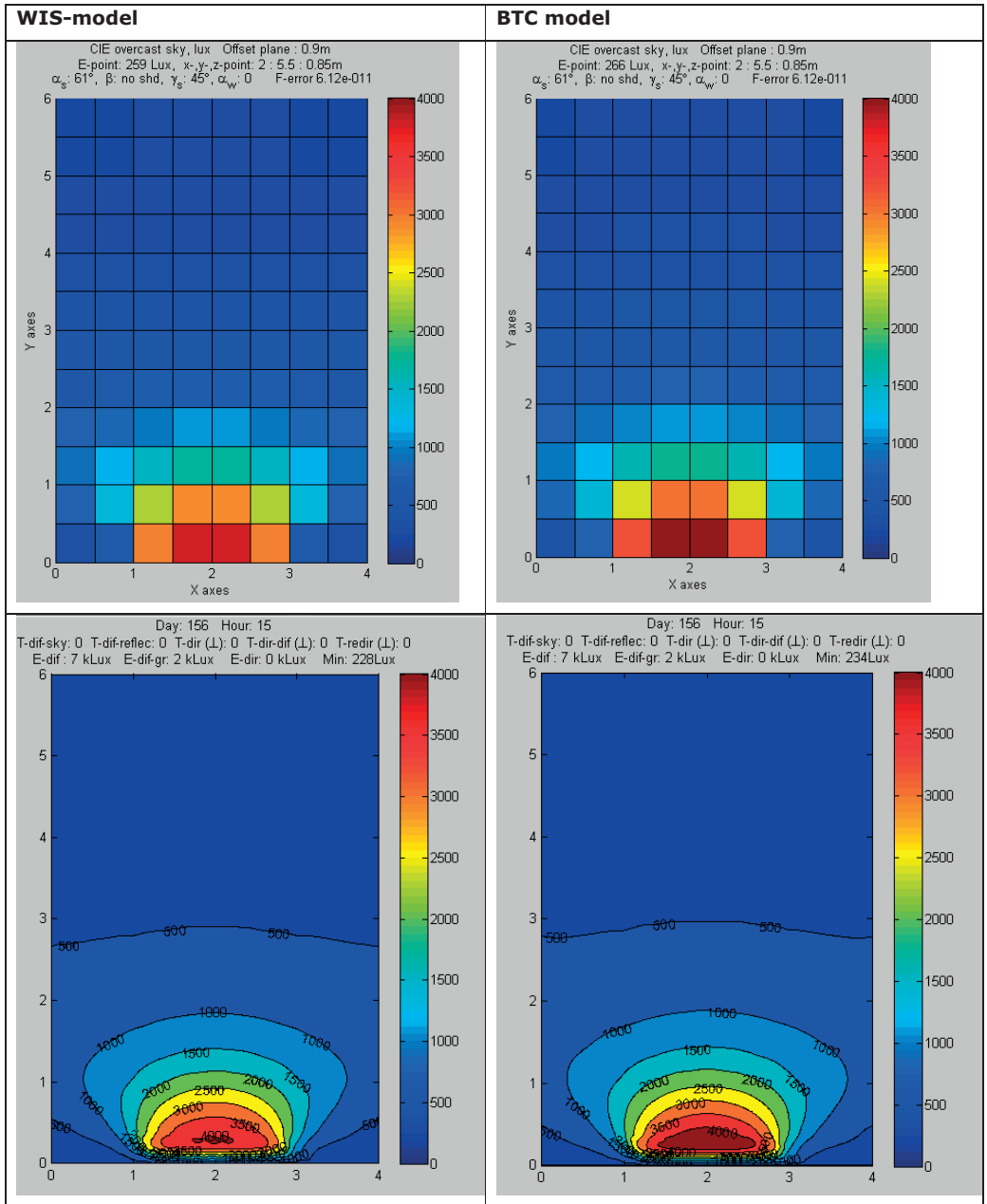

Figure 6. Test results of implementation.

4 Conclusion

This report is describing a method for predicting the daylight performance of CFS. The method is implemented in an existing daylight calculation tool (LightCalc), and is tested for accuracy. A full validation of the method has not been possible due to the deadline of the PhD thesis to which this report belongs. However, a minor validation of the algorithm shows plausible results.

Future work is to make a complete validation by comparing the output from the implemented method with the output from the validation in LightCalc paper [4]. This means that 1) the BTC of the CFS described in ref. [4] should be generated using e.g. the Opticad-based model provided by Moeller [18], 2) the BTC is in a simulation using the suggested method, and 3) the result is compared with the Radiance calculations performed in ref. [4]. Expected result is a smaller relative error compared to the error of the current method in LightCalc (uni-directional transmittances).

5 References

- [1] Petersen S, Svendsen S. Method and simulation program informed decisions in the early stages of building design, *Energy and Buildings* 42 (2010) 1113-1119.
- [2] WinDat, 2006. Window Information System software (WIS), WinDat Thematic Network, TNO Bouw, Netherlands, <http://www.windat.org>.
- [3] van Dijk, D., Oversloot, H. WIS, the European tool to calculate thermal and solar properties of windows and window components. In: *Proceedings of IBPSA, Building Simulation, Eindhoven, Netherlands, (2003)* 259-266.
- [4] C.A. Hviid, T.R. Nielsen and S. Svendsen, Simple tool to evaluate the impact of daylight on building energy consumption, *Solar Energy* 82 (9) (2008) 787-798
- [5] Klems J H, Warner J L. Measurement of bidirectional optical properties of complex shading devices. *ASHRAE Transactions* (1) (1995) 791-801
- [6] Andersen M, Rubin M, Scartezzini J-L. Comparison between ray-tracing simulations and bi-directional transmission measurements on prismatic glazing. *Solar Energy* 74 (2) (2002) 157-175
- [7] Commission Internationale de l'Eclairage, *Radiometric and Photometric Characteristics of Materials and their Measurement*, 2nd Edition, CIE 38 (TC-2.3), Paris (1977), 214 pp.
- [8] Aydinli H, Kaase H. Measurement of Luminous Characteristics of Daylighting Materials, A Report of IEA SHCP TASK 21/ECBCS ANNEX 29, Technical University of Berlin (1999), 51 pp.
- [9] M. Andersen, J. de Boer, Goniophotometry and assessment of bi-directional photometric properties of complex fenestration systems, *Energy and Buildings* 38 (2006) 836-848.
- [10] J. de Boer, Numerical Goniophotometer, User Manual, Fraunhofer Institute for Building Physics, Stuttgart, 2004.
- [11] Reinhart C F, Andersen M. Development and validation of a Radiance model for a translucent panel. *Energy and Buildings* 38 (7) (2006) 890-904
- [12] Tregenza P R, Waters I M. Daylight coefficients. *Lighting Research & Technology* 15 (2) (1983) 65-71

- [13] Ward G L, Shakespeare R A. *Rendering With Radiance – The Art and Science of Lighting Visualization*, second ed. Morgan Kaufmann, San Francisco 1998.
- [14] U.S. Department of Energy, EnergyPlus Energy Simulations Software website, www.eere.energy.gov/buildings/energyplus/.
- [15] Carroll W L, Hitchcock R J. Delight2 daylighting analysis in EnergyPlus: Integration and preliminary user results. In: *Proceedings of IBPSA, Building Simulation, Montreal, Canada (2005)* 139–144.
- [16] Kim J J, Papamichael K M, Selkowitz S, Spitzglas M, Modest M. Determining daylight illuminance in rooms having complex fenestration systems. *Technical proceedings from the '1986 International daylighting conference'*, Long beach, CA, 1988
- [17] Kaempf J H, Scartezini J-L. Integration of BT(R)DF Data into Radiance Lighting Simulation Programme. Technical Report CTI Project 4881.1 "Bidirectional Goniophotometer", Solar Energy and Building Physics Laboratory, EPFL 2004, 35 pp.
- [18] Moeller P. Generating Bi-Directional Transmittance Function data in OptiCad for LightCalc. MSc thesis, Technical University of Denmark, October 2009, 132 pp.
- [19] Perez R, Seals R, Michalsky J. All-weather model for sky luminance distribution – preliminary configuration and validation. *Solar Energy* 50 (3) (1993) 235–245.
- [20] Reinhart C. *Daylight Availability and Manual Lighting Control in Office Buildings – Simulation Studies and Analysis of Measurements*, PhD thesis at the University of Karlsruhe, 2001.
- [21] Tregenza P R. Subdivision of the sky hemisphere for luminance measurements. *Lighting Research and Technology* 19 (1) (1987) 13–14.
- [22] Mardaljevic J. *Daylight Simulation: Validation, Sky Models and Daylight Coefficients*. PhD thesis at De Montfort University, Leicester (1999) 280 pp.

Appendix 1 for report I

This appendix contains the ordering and numbering scheme for the sky vault, complete with the altitude and azimuth for each patch centre as defined by Tregenza [21]. The 145 elements are numbered 1 to 145, and count 'clockwise' from North i.e. N -> E -> S -> W [22].

Patch ID
Alt(θ), Azi(φ)

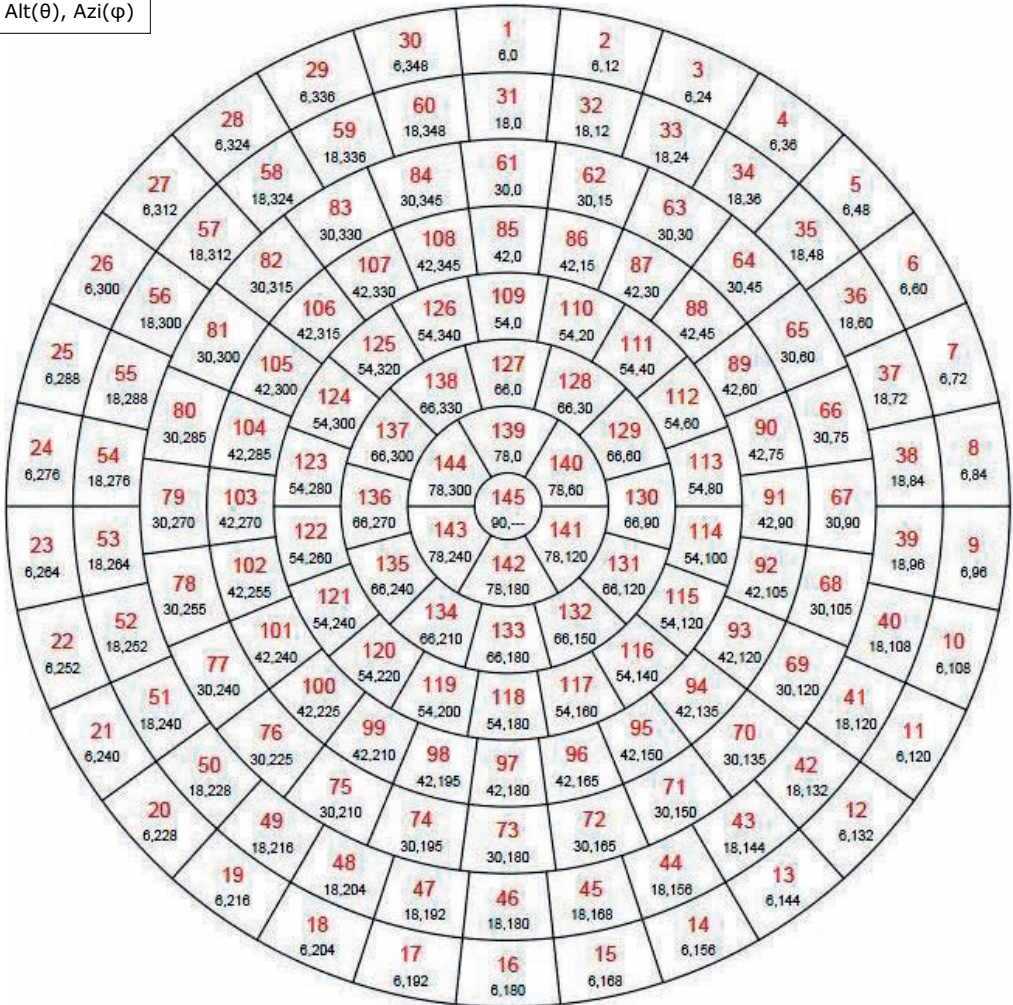

Appendix B: Course description of master course 11115 Building energy and technical services - Integrated design

Danish title:	Bygningsenergi og -installationer - Integreret design http://www.kurser.dtu.dk/11115.aspx?menulanguage=en-GB
Language:	English
Point (ECTS)	5
Course type:	BSc/MSc- Advanced Course

Scope and form:	Lectures and group work
Duration of Course:	13 weeks
Type of assessment:	Evaluation of exercises/reports
Aid:	Written works of reference are permitted
Evaluation:	7 step scale, internal examiner

General course objectives:

To enable the participants to perform an integrated design process with focus on building envelopes and windows as well as technical services, which taken together, best meet the requirements for the indoor environment, total energy consumption and total economy over the service life time of the building. The integrated design process may be used for all types of buildings. The aim of the integrated design process is to combine calculations and evaluations in a rational decision process.

Learning objectives:

A student who has met the objectives of the course will be able to:

- set up the basis (requirements and requests) for integrated design of a building with focus on indoor environment and energy consumption
- calculate the indoor environment and the energy consumption for typical rooms and for the whole building by use of dynamic calculation models with relatively few input data for the geometry , the building envelope and the building services
- perform preliminary analyses based on calculations of the influence of the design parameters on the indoor environment and the energy consumption

- set up different proposals for design of a building that fulfils the minimum requirements to the indoor environment and the energy consumption
- perform detailed calculations of the indoor environment and the energy consumption of the different proposals for design of the building
- evaluate the performance of the different design proposals with respect to the design requirements
- write summarising reports to communicate the results of the activities listed above to the other participants in the design work
- write reports that documents the calculations, analyses and evaluations for the internal files on the specific project

Content:

Integrated design and analysis of buildings based on commonly applied solutions in the fields: building envelope, windows and glass façades, heating and ventilation systems, and other relevant building components and technical services.

Methods and calculation programs for an overall treatment of building envelopes and technical services with regard to indoor environment and total energy consumption - expressed in the general term: building performances. Methods for integrated design includes: formulating performance requirements, setting up space of solutions based on analyses of the performances of the building with respect to the primary design parameters, setting up design proposals, performing analyses and evaluation of the design proposals based on detailed calculations of the performances of the building design.

Examples of specific design parameters: form and orientation of the building, façade solutions, insulation standards, selection of heating, ventilation and air conditioning systems, routings for pipes and ducts.

Department: 11 Department of Civil Engineering

Keywords: Integrated design , building envelope and windows, technical building services, total energy consumption, total economy

Appendix C: Raw data from master course

Raw data from master course in 2006.

Group no	Office	Seminar room	Comment	Country	Background
Gr. 1	3	3	No comment	Danish	M.Sc. in Civil Engineering
Gr. 2	3	3	No comment	Danish	M.Sc. in Civil Engineering
Gr 3	0	0	Misunderstanding of concept. A number of parameter variations but no attempts to design rooms	Foreigner	M.Sc. in Environmental Engineering / N/A
Gr. 4	1	1	Have only made one 'optimal' solution - missed the point of the assignment	Danish	M.Sc. in Civil Engineering
Gr. 5	1	1	Have only made one 'optimal' solution - missed the point of the assignment	Foreigner	N/A
Gr. 6	1	1	Have only made one 'optimal' solution - missed the point of the assignment	Mixed	M.Sc. in Civil Engineering
Gr. 7	3	3	No comment	Danish	M.Sc. in Civil Engineering
Gr. 8	0	0	One room suggested but it is not fulfilling requirements (energy or thermal IE)	Danish	M.Sc. in Civil Engineering
Gr. 9	3	3	No comment	Danish	M.Sc. in Civil Engineering
Gr. 10	3	3	No comment	Danish	M.Sc. in Civil Engineering
Gr. 11	1	1	Have only made one 'optimal' solution - missed the point of the assignment	Danish	M.Sc. in Civil Engineering
Gr. 13	1	1	Have only made one 'optimal' solution - missed the point of the assignment	Foreigner	M.Sc. in Civil Engineering
Gr. 14	1	1	Have only made one 'optimal' solution - missed the point of the assignment	Foreigner	N/A

Raw data from master course in 2007.

Group no.	Office	Seminar room	Comment	Country	Background
Gr. 2	3	3	Very good. They indicate even more possibilities	Danish	M.Sc. in Civil Engineering
Gr. 3	0	0	Misunderstanding of concept. A number of parameter variations but no attempts to design rooms	Foreigner	N/A
Gr. 4	3	3	Very good. They indicate even more possibilities	Danish	M.Sc. in Civil Engineering
Gr. 5	3	3	Very good. They indicate even more possibilities	Danish	M.Sc. in Architectural Engineering
Gr. 6	0	0	Misunderstanding. Parameter variations but not even one room designed.	Danish	M.Sc. in Civil Engineering
Gr. 7	3	3	Delivers 2x3 rooms using the tool as intended	Danish	M.Sc. in Civil Engineering
Gr. 9	2	2	Only did 2x2 rooms instead of 2x3 rooms - misinterpretation of assignment	Foreigner	N/A
Gr. 10	3	3	Very good. They indicate even more possibilities for office designs	Danish	M.Sc. in Architectural Engineering
Gr. 11	2	2	Only did 2x2 rooms instead of 2x3 rooms - misinterpretation of assignment	Foreigner	N/A
Gr. 12	0	0	Misunderstanding of concept. A number of parameter variations but no attempts to design rooms	Danish	M.Sc. in Civil Engineering
Gr. 13	3	3	Delivers 2x3 rooms using the tool as intended but also for some reason suggesting additional designs which is not fulfilling the performance requirements	Foreigner	M.Sc. in Civil Engineering
Gr. 14	0	0	Misunderstanding of concept. A number of parameter variations but no attempts to design rooms	Danish	M.Sc. in Civil Engineering
Gr. 15	3	3	Delivers 2x3 rooms using the tool as intended	Mixed	M.Sc. in Civil Engineering
Gr. 16	N/A	N/A	Special case. The group made a different task with relevance to their master thesis	Foreigner	M.Sc. in Architectural Engineering

Raw data from master course in 2008.

Group no.	Office	Class room	Comment	Country	Background
Gr. 1	3	1	Had problems to design classroom with low energy consumption	Danish	M.Sc. in Civil Engineering
Gr. 2	1	0	Great effort but they end up with designs 3-10 kWh/m ² year above the energy requirement	Danish	M.Sc. in Civil Engineering
Gr. 3	3	2	Last suggestion for lecture room is not fulfilling energy performance requirement	Danish	M.Sc. in Architectural Engineering
Gr. 4	3	3	Very good. They indicate even more possibilities for office	Foreigner	N/A
Gr. 5	1	1	Great effort but they end up with designs 3-10 kWh/m ² year above the energy requirement	Mixed	Architect / N/A
Gr. 6	3	3	Very good. They indicate even more possibilities for office	Danish	M.Sc. in Civil Engineering
Gr. 7	2	3	For some reason the group have only reported two suggestions for office dersigns even though their paramter variations seems to enable them to generate more.	Foreigner	M.Sc. in Civil Engineering
Gr. 8	3	3	Very good. They indicate even more possibilities for the office and for the lecture room	Danish	M.Sc. in Civil Engineering
Gr. 9	3	0	Had problems to design classroom with low energy consumption. All suggestions were 3-10 kWh/m ² year above the energy requirement	Danish	B.Sc. in Architectural Engineering
Gr. 10	3	3	Their parameter variations would have allowed them to suggest more than 2x3 designs	Danish	M.Sc. in Architectural Engineering
Gr. 12	3	3	Very good. They indicate even more possibilities for the office and for the lecture room	Foreigner	M.Sc. in Civil Engineering
Gr. 13	3	1	Had problems to design classroom with low energy consumption. All suggestions were 3-10 kWh/m ² year above the energy requirement	Danish	N/A
Gr. 14	3	0	More than 3 offices but had problems to design classroom with low energy consumption. All suggestions were 10-20 kWh/m ² year above the energy requirement	Mixed	M.Sc. in Civil Engineering
Gr. 15	3	2	More than 3 offices but only suggest 2 classroom designs.	Danish	M.Sc. in Civil Engineering
Gr. 16	3	0	More than 3 offices but had problems to design classroom with low energy consumption. All suggestions were 4-7 kWh/m ² year above the energy requirement	Danish	M.Sc. in Architectural Engineering

Gr. 17	3	3	Very good. They indicate even more possibilities for the office and for the lecture room	Danish	M.Sc. in Architectural Engineering
Gr. 18	0	0	Nothing is right in this report so it is not assessed.	Foreigner	M.Sc. in Civil Engineering

Raw data from master course in 2008.

Group no.	Office	Seminar room	Comment	Country	Background
Gr. 1	1	1	Have only made one 'optimal' solution - missed the point of the assignment	Foreigner	M.Sc. in Civil Engineering / M.Sc. in Architectural Engineering
Gr. 2	2	3	Not able to design a north-facing office in low energy class 1	Danish	M.Sc. in Architectural Engineering
Gr. 3	2	0	Office 3 did not fulfil requirement for thermal indoor environment. The lecture rooms fulfils the energy frame but none of the lecture rooms fulfils the demand regarding thermal indoor environment	Mixed	N/A
Gr. 4	3	3	No comments	Danish	M.Sc. in Architectural Engineering
Gr. 5	3	3	No comments	Danish	M.Sc. in Civil Engineering
Gr. 6	3	2	Last class room did not fulfil requirement for thermal indoor environment	Danish	M.Sc. in Sustainable Energy / M.Sc. in Civil Engineering
Gr. 7	1	1	Have only made one 'optimal' solution - missed the point of the assignment	Foreigner	N/A
Gr. 8	2	3	Office 3 did not fulfil requirement for air quality.	Mixed	M.Sc. in Civil Engineering
Gr. 9	3	3	No comments	Foreigner	M.Sc. in Civil Engineering
Gr. 10	2	2	Have misunderstood that they were supposed to make three versions of each function.	Foreigner	M.Sc. in Civil Engineering
Gr. 11	3	3	Very good. They indicate even more possibilities for the office and for the lecture room	Danish	M.Sc. in Civil Engineering
Gr. 12	3	3	Very good. They indicate even more possibilities for the office and for the lecture room	Danish	M.Sc. in Civil Engineering
Gr. 13	3	3	No comments	Mixed	M.Sc. in Civil Engineering / M.Sc. in Sustainable Energy
Gr. 14	3	3	No comments	Foreigner	N/A
Gr. 15	2	2	Office 3 and lecture room 3 did	Danish	M.Sc. in Civil

			not fulfil requirement for thermal indoor environment.		Engineering
Gr. 16	1	1	have only made one solution - missed the point	Danish	M.Sc. in Architectural Engineering
Gr. 18	3	3	No comments	Danish	N/A
Gr. 19	3	3	No comments	Danish	M.Sc. in Architectural Engineering
Gr. 20	3	3	Very good. They indicate even more possibilities for the office and for the lecture room	Danish	M.Sc. in Architectural Engineering / M.Sc. in Civil Engineering
Gr. 21	1	1	have only made one solution - missed the point	Foreigner	N/A
Gr. 22	3	3	No comments	Foreigner	M.Sc. in Civil Engineering
Gr. 23	3	3	No comments	Danish	N/A

This thesis reports on four years of research with the aim to contribute to the implementation of low-energy office buildings with high quality of indoor environment and good total economy. The objective is to enable the energy expert of the building design team to generate a useful input to the overall building design process prior to any actual form giving of the building. A workflow operationalised in a building simulation tool was proposed, tested and developed in an iterative manner involving 135 students at DTU. The tool was furthermore used in the early stages of three real building design projects.

The end result is a method and tool which enables the energy expert proactively to generate a useful input to the overall building design process.

DTU Civil Engineering
Department of Civil Engineering
Technical University of Denmark

Brovej, Building 118
2800 Kgs. Lyngby
Telephone 45 25 17 00

www.byg.dtu.dk

ISBN: 9788778773289
ISSN: 1601-2917